

VTL

TL5.5 Series II Signature Preamplifier

Owner's Manual

MAKING TUBES USER FRIENDLY

VTL TL5.5 Series II Signature Preamplifier

Information in this document is subject to change without notice. No part of this document may be reproduced or transmitted in any form or by any means, electronic or mechanical, for any purpose, without the express written permission by VTL.

Version History:

Version 2.0 May 19, 2010

Part Number: OM-6.5

Copyright © 2011 by VTL Amplifiers Inc. All rights reserved.
4774 Murrieta Street, Suite 10
Chino, CA 91710, USA
Phone 909.627.5944 • Fax 909.627.6988
Email: mail@vtl.com • <http://www.vtl.com/>

Table of Contents

Chapter 1	1
Introduction	1
Symbol Conventions used in this guide	2
Electrical Safety Notice	2
Water and Moisture	3
Location and Ventilation	3
Servicing	3
Operational Warnings.....	4
Chapter 2	5
Getting Started	5
Unpacking the TL5.5 from its box	5
Quick Start	6
TL5.5 Front Panel Controls.....	7
The Preamplifier's Back Panel.....	10
Back Panel Connections and controls	10
The Remote Control Hand-held Unit	11
Fitting the Batteries to the Remote Control.....	12
Voltage Setting	13
Power Source for the VTL TL-5.5 Preamplifier	13
Connecting the Preamplifier to your system	14
Connecting to a Turntable	14
Select and Connect Source Components.....	14
Connecting to a Turntable	15
Connecting the TL5.5 to a Home Theater System	16
Using the TL-5.5 to trigger other devices	16
Chapter 3	18
Operating the Preamplifier	18
Powering your preamplifier and the rest of your system on	18
Ground Loop Hum.....	19
Using the Preamplifier with the Remote Control	19
Using the Tape Loop to monitor recordings	20
Connecting to the Turntable	21
Operating Modes and Factory Default Settings.....	21
Quick Reference: Special Programming Functions	22
LED Indications.....	23
Programming the Preamplifier's function controls	25
Using the preamplifier with RS232 control	35
Powering the system off	39
chapter 4	41
Care and Maintenance of your VTL preamplifier	41
Break In Period	41
Tube Life.....	41
Changing Tubes.....	41

Changing the Main Fuses.....	44
Internal View of TL5.5 II Line Stage	45
Internal View of TL5.5 II Line and Phono Stage	45
Internal View of TL5.5 II Phono Stage	46
Cleaning.....	46
Troubleshooting	46
chapter 5	49
TL-5.5II Specifications	49
Chapter 6.....	51
Warranty.....	51
Appendix.....	53
Warranty Registration	53
Service Notes.....	53

Introduction

Congratulations on your purchase of a VTL Signature Preamplifier: “A new single-chassis preamplifier design to challenge all others.”

This hand crafted component is designed to deliver superb performance for your listening pleasure for many years to come. In order to get the most benefit from your purchase, we recommend that you take sufficient time to get familiar with the features of this product. Please take a moment to read through this owner’s manual, as it contains all of the installation procedures needed to connect your new TL5.5 to the rest of your audio system, as well as the many functions that the TL5.5 can perform. After you have finished reading this manual it should be kept in a safe place for future reference.

Since its introduction in 1997, the TL-5.5 has earned a reputation for outstanding performance at an economical price. Now, VTL has significantly upgraded this preamp, using many of the technological innovations derived from the flagship TL-7.5 preamplifier. The result is a modern full-featured preamplifier – the TL5.5 Series II Preamplifier that outperforms in every way, making it one of the top values of any tube preamplifier in its category.

The fundamental qualities that made the original TL-5.5 special—its all-tube design, the optional retrofittable phono stage, and its superb sonic characteristics—are unchanged. What’s new is the application of advanced audio technology sourced from VTL’s TL-7.5 Reference and TL-6.5 Signature preamplifiers. This technology uses a simple circuit topology with low negative feedback and a high current/low impedance output stage in a low-noise microprocessor-based design. Top quality parts, fully balanced operation, and precision-regulated and shielded power supplies yield a full yet neutral sound with high resolution, transparency, speed and powerful dynamics.

Preamplifiers offer the user many benefits that direct connections cannot. A line stage with gain (and therefore dynamic headroom) always yields superior sound in dynamic musical passages. Ease of installation is another primary benefit with preamplifiers.

The VTL TL5.5 Signature Line preamplifier is both a fully active line level preamplifier and a complete source control center in one package, and it offers complete predictability of performance with little or no change of response in a wide range of systems and environments.

VTL has delivered on its goal of bringing advanced engineering and modern functionality to the new TL-5.5 Series II preamplifier. With the same highly intuitive user interface of the renowned TL-7.5 and 6.5, and a full-function remote, the new TL-5.5 is a pleasure to use. A rigid, well-shielded chassis yields quiet operation while bi-directional RS-232 serial interface allows for seamless integration into any audio system. A luxurious cosmetic makeover includes a sleek and visually striking precision-milled faceplate similar to those used on its much more expensive brethren. For a well-

priced, high-performance all-tube preamplifier, the TL-5.5 is a truly fine addition to any system.

The VTL team is proud that you have selected our Signature preamplifier as a new member of your home audio system. This preamplifier is designed to give you the convenience and flexibility to manage all your audio and video sources, while at the same time giving you the musical experience that is the most alive and the truest to your source, and we certainly wish you many hours of enjoyment from it.

Symbol Conventions used in this guide

Certain symbols are used in this owner's manual to draw your attention to important points being discussed. For your own safety and that of your equipment you should note and heed the warnings that follow these symbols.

The "Warning - Pay particular Attention" symbol used is



And the "Warning – Observe These Precautions for Your Safety" is



Electrical Safety Notice

Electrical voltage from power cables can be hazardous. We recommend that the power cord used with this unit be connected to a properly grounded AC outlet. There are hazardous voltages present in the unit, and to prevent electrical shock, do not remove the cover of this preamplifier, and under no circumstances while the unit is powered on.



Warning – Under no circumstances should any attempt be made to circumvent the ground system to the AC line for any reason. Using a ground lifted system can be potentially extremely dangerous, both to persons that might come in contact with the unit, and to the unit itself, and proper RF shielding cannot be attained without a secure ground connection.



Damage to the unit that is the result of improper AC connection and grounding will not be covered under the warranty.

Prior to connecting this preamplifier to any audio or video equipment in your system, make sure this unit's power (and the rest of the equipment connected to its input and output channels) is turned off. Adding or removing input or output cables to the preamplifier while the system is powered on can cause damage to the preamplifier and possibly also to the rest of the system.



Water and Moisture

The TL5.5 should be kept away from sources of water or moisture. If liquid enters the unit it must be immediately returned to your dealer for servicing. In this case you should under no circumstances try to power the unit on - there are hazardous voltages present in this unit that can cause serious injury if they come in contact with you.



Location and Ventilation

Warning – To avoid risk of failure due to overheating, do not stack components

The TL5.5 chassis emits heat and needs proper ventilation to ensure long operational life. Under no circumstances should the TL5.5 SERIES II be stacked on top of any other unit.



Ensure that the TL5.5 SERIES II is installed in a location that is stable and well ventilated. If the preamplifier is placed in a built-in installation, ensure that there is adequate room for air to flow through the ventilation openings. Allow at least 3 - 5 inches clearance on the top and around the sides of each chassis of the preamplifier. The warranty does not cover units that are damaged due to overheating from incorrect installation.



It is also recommended that the preamplifier be sited at least 10 inches away from the power amplifier to prevent possible noise introduction into the system.

Tiptoes or other isolation accessories may prove useful in reducing mechanical vibrations or other external vibrations that might affect sonic performance, and we have found that such accessories can offer definite beneficial sonic improvements when used correctly. In all cases this preamplifier should only be installed in a location that is stable, as warranty does not cover damage due to the unit falling.

Do not place the preamplifier next to heat sources such as radiators, stoves or other appliances.

Do not place the preamplifier where small children might be able to tamper with the equipment. If it is not possible to place the preamplifier out of the reach of small children it is recommended that power cables be removed when the equipment is not in use.

Servicing

Do not attempt to service the TL5.5 beyond the procedures described in this manual. For all other service and questions, please contact your authorized VTL dealer or the factory.



Operational Warnings



- It is critical for proper sonic performance of this component that it be properly configured for the mode of operation while playing. If a balanced signal is applied to the inputs the unit must be configured for balanced operation, and vice-versa.



- Always make all connections before powering the TL5.5 on. Connecting or disconnecting the TL5.5 while powered on can damage the output stage, and will not be covered under the warranty. Ensure that no interconnect cables can become loose during use and that there are no intermittent faults or shorts with the cables.



- Do not attempt to disassemble the TL5.5 chassis or remove any covers from the unit. Always consult with your VTL authorized dealer or the VTL factory before attempting any service work on any VTL unit.



- Do not touch the tubes after the TL5.5 is turned on. The tubes can get very hot while the TL5.5 is operating. Turn off the TL5.5 and allow the tubes to cool down before attempting to work with the tubes.



- Tube components can be heavy and awkward to lift, with the weight unevenly distributed, and you should not attempt to move the unit without help. The TL5.5 Preamplifier weighs approximately 40 lbs. (18.14 Kg).



- Do not exceed fuse ratings or attempt to bypass any fuses, as this can cause an extremely hazardous condition and will void any warranties. Use only the same type and rating of fuses as specified in the owners' manual and marked on the unit.

Getting Started

Unpacking the TL5.5 from its box

1. The VTL TL5.5 Preamplifier is shipped in 1 carton and the unit is wrapped in thick plastic.  The plastic is not strong enough to support the unit, and may tear if you try to lift the unit out of the box with it. Also there are protruding switches and connectors which could break if the unit is not properly handled, and in addition to the awkward, unbalanced heavy load the unit has sharp edges and a cleaning polish on it, which makes it slippery and hard to grasp.
 2. When lifting the unit, be sure to only lift it from the bottom of the unit with both hands. Be careful not to break any switches or to rest the unit on any other side than the bottom side on the four feet on a stable surface. Setting it on any other side may damage protruding components.
- ➔ SAVE THE CARTON AND ALL PACKAGING FOR ANY FUTURE SHIPMENT OF THE TL5.5.

After you open the carton you should find the following items inside:

- The preamplifier
- 1 standard power cord for the electrical system in your country
- The remote control hand-held unit with two AAA batteries
- This Owner's Manual, Quick Reference Sheet, VTL Quality Assurance and test printout, and a VTL product warranty registration card

Remove each item from its packaging material and check to make sure that no physical damage has occurred during shipment of the unit. There should be no rattles inside either the preamplifier chassis or remote control units. Look through the vent slots and check to see that the tubes appear properly seated in their sockets. Contact your VTL dealer immediately if physical damage is detected.

Quick Start

As the proud owner of this new VTL TL5.5 Signature preamplifier, you are probably eager at this moment to connect the new preamplifier into your system and hear what it sounds like. This section is a quick setup-up guide to help you get started in the shortest time possible. Once the preamplifier is in your system and operational, please take the time to read the rest of the information in this manual. It will give you the in-depth perspective into all the functions your preamplifier is capable of delivering and how to take advantage of the many special programming functions designed to give you the maximum performance and flexibility.

Step 1: Finding a location for the TL5.5 Preamplifier

We recommend that you place the TL5.5 preamplifier in a location closer to your source components, such as your CD player, turntable, or DVD player. Note that the TL5.5 should not be stacked on top of anything else. Reserve sufficient space to either put the unit on its own shelf with at least 6 inches of space above it for ventilation.

Step 2: Connect the TL5.5 Preamplifier to the AC outlet

Make sure that the *Power Rocker* switch on the back of the unit is not turned on. Locate the IEC power cord that came with your TL5.5 preamplifier, and connect one end of the power cord to the back of the unit and the other side of the power cord to the AC outlet on the wall.

Step 3: Connect a Source to the Preamplifier

Make sure the source is turned off, connect the source that you use most frequently, e.g. your CD player, to the CD or AUX1 input locations in the back panel of the unit. If your CD player has balanced out, connect the cable from the balanced output of your CD player to the CD balanced input of your TL5.5 preamplifier, matching the left and right channels. Make sure that you are using the appropriate balanced input cables.

If your CD player uses single-ended outputs, connect the cable from the single-ended output of your CD player to the CD or AUX1 single-ended input of your TL5.5 preamplifier, matching the left and right channels. The single-ended input for CD or AUX1 is located immediately to the right of the XLR connector.

Step 4: Connect your Power Amplifier to the Preamplifier

Make sure your Power Amplifier is turned off. If your power amplifier supports balanced input and you have balanced interconnects, connect the preamplifier's balanced output to the power amplifier's balanced input, with the right output from the preamplifier going to the right input of the amplifier and the left output of the preamplifier to the left input of the amplifier.

If you are connecting to your power amplifier using single-ended interconnects, connect one of the preamplifier's RCA/single-ended outputs to the amplifier's single-ended input, making sure the left channel of the preamplifier is connected to the left channel of the amplifier and vice versa. The single-ended output is located to the left of the balanced output connector.

Step 5. Turn on the TL5.5 Preamplifier

Locate the Power Rocker switch at the back of the unit. Turn the switch to the “on” position. You should see two blue “--“ displayed in the unit’s Numeric Display window.

Locate the red Power button on the front panel of the unit located on the far left side of the Preamplifier. Push the power button to turn on the Preamplifier. You will see the blue Power on LED above the red Power button start to blink and the Numeric Display now displays the 90 to 0 warm-up countdown sequence.

Step 6. Turn on your Source component

Step 7. Turn on your Power Amplifier(s)

Step 8. Wait for the TL5.5 preamplifier to finish warmup

After the TL5.5’s warm-up countdown is completed, the Power on LED turns to a steady blue indicating that the unit is now ready to play. Please note that the Numeric Display now indicates 00 volume. CD is the selected source and the LED above CD is blue to indicate that the default selection of CD is in balanced mode. If your Source component is setup in balanced mode, you are now ready to play your music. Turn the volume to the appropriate level by rotating the Volume/Control knob.

If your Source component is used in single-ended mode, change the CD input to single-ended by holding down the CD button until the LED changes to green. Start playing your music and turn the volume to the appropriate level by rotating the Volume/Control knob.

Congratulations! Your TL-5.5 Preamplifier is now beginning its break-in period. Now please read the rest of this manual while relaxing and listening to your favorite music.

TL5.5 Front Panel Controls

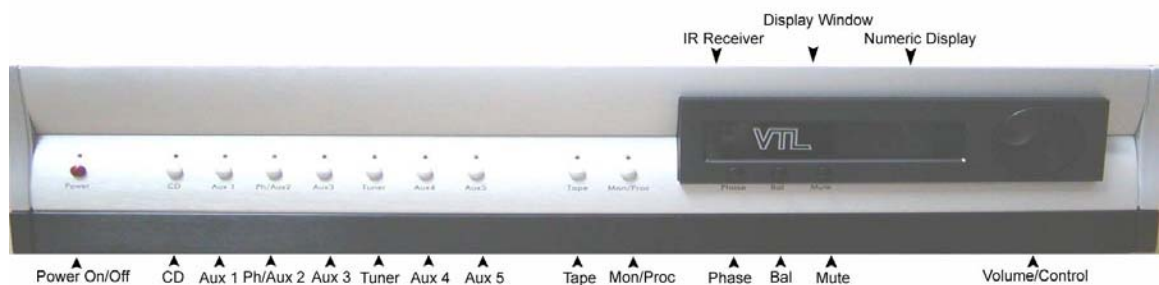

TL-5.5 II Front Panel

From the front panel of the unit you can access all of the controls and program all the functions of the preamplifier. All functions can also be accessed and programmed from the rear-mounted RS-232 serial port, either via a central remote control system or simply from a computer with serial capabilities.

You can operate the various controls and buttons from the front panel to access the full functionality of this unit, and the operational functionality can also be accessed via the remote control. The indication LEDs show the various operating modes of the unit.

1. The *Power* button is used to turn the preamplifier on and off. If the unit is powered off press the button to turn the preamplifier ON and press the button down again to turn the unit OFF. The *Power* LED will blink blue during warmup, remain on steady blue after power up, and turn off during power off or standby.
2. The *Input Select* buttons are used to select the source component for the preamplifier. Any of the inputs can be selected by pressing the appropriate selector button labeled with the selection of your choice. The input selectors are grouped by function: The first two from left to right can be configured as either balanced or single ended inputs. During power up these two buttons also double as trigger programming buttons (when not in locked mode).

If triggers are programmed the first two input LEDs flash red during power up to indicate trigger functions, and these two inputs can also be set for balanced (blue) or single ended (green) operation.

The third input from the left is marked *Ph/Aux2*, and can be selected as either an RIAA equalized phono input (if a phono card is installed in the unit), or as the input that an external phono stage is connected to, or as a regular line input if there is no phono stage. This input and the following four are single ended inputs only, and are not used for any other function. The LED color is permanently green.

Warning It is critical for proper sonic performance of this component that it be properly configured for the type of connection and mode of operation: If a balanced signal is applied to the input that input must be configured for balanced operation, and vice-versa.



3. The *Tape* input is also usable as a normal (single ended only) input, with the additional capability of handling the record monitor function. LED color is green for input, and red for monitor.
4. The *Mon/Proc* button is used to monitor the output when recording, and allows the *Tape* input to be routed to the preamplifier output while the selected input is routed to the Record out, to monitor the recording at the desired volume level while keeping the selected input connected to the Record Out at a fixed level.

The *Mon/Proc* button is also used to set any input for unity gain (when not in locked mode). This function is used for routing an external surround processor to the front left and right channels. In this mode, your external surround processor will control the levels of all of the channels of your system, including the front left and right channels. In this mode the preamplifier is in the unity gain mode, and the volume control is set to a fixed position (equivalent to volume position 69 in single ended mode). The signal is passed to the front left and right amplifiers through the gain stage of the preamplifier, but at the same volume as the surround processor is putting out, and the preamplifier's volume control is disabled.

5. The *display window* contains the group of three main operational buttons and display LEDs, the numeric display, and the infra-red remote receiver, which enables the transmission of signal from the remote hand-held unit to be received by the preamplifier. Keep this window clear from any obstruction and out of direct light to allow maximum signal transmission from the remote wand.

The three main operational buttons are:-

- a) The *Phase* button allows you to switch the system into the phase reversed state.
 - Pressing the *Phase* button toggles the system between the Phase 0 and Phase 180 (inverted) states. The *Phase* LED will turn off when the system is in Phase 0 state, and will be steady red in the phase inverted state.
- b) The *Balance* button allows the user to change the channel balance setting between left and right channel.
 - Select the *Balance* button changes the display to the balance display and sets the *Balance* LED to blue. While the display is indicating “—“, turn the rotary knob changes balance from left to right, according to the direction of rotation. In this mode the control knob is used to set the left and right channel level.

In the *Balance* mode, when the display shows a double dash this indicates that the left and right channels are equally balanced. A number with a bar on either side indicates an out of balance setting, with the bar indicating the direction of balance and the display indicating the degree of out of balance.

The display automatically reverts to volume readout a few seconds after release of the *Balance* button.

- c) The *Mute* button is to allow the user to switch the preamplifier into the muted state.

Pressing the button toggles the system between the muted and operating states. If the preamplifier is currently in the operating state, pressing the *Mute* button will set the unit to the muted state, indicated by a flashing red *Mute* LED. If the preamplifier is currently in mute state, pressing the *Mute* button will change the system into the operating state, and the LED will turn off.

The *Numeric* display is used to indicate either the sequential countdown timer during power-up, offset level of the selected input, channel balance offset, trigger timing during trigger output programming (during power up only), and the overall volume gain level setting.

6. The *Control knob* is used in conjunction with the *Numeric Display* for setting volume gain level in the operate mode, or when in one of the programming modes (trigger programming, channel balance setting or input offset programming mode) the control knob is used to dial in the appropriate setting.

- When in volume control mode the control knob changes the loudness level of the output from your speaker system. Turning the knob clockwise increases the volume level, and turning the knob counter-clockwise decrease s the volume level.

The Preamplifier's Back Panel

From the back panel of the chassis you can access the power connector, trigger outputs, RS-232 port, AC fuse, and the serial number and power consumption of the unit, as well as all of the audio inputs and outputs.

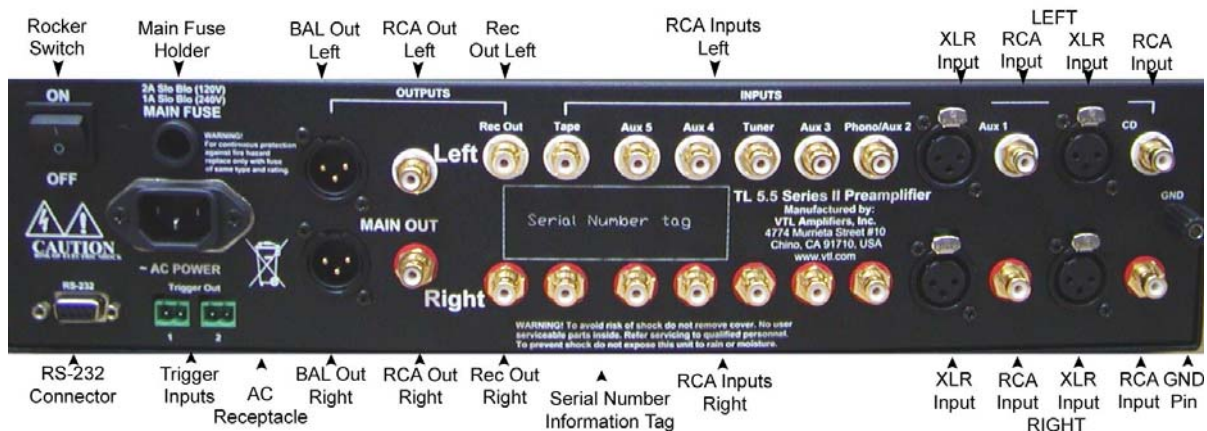

Fig. 2 Rear Panel

Back Panel Connections and controls

- ➔ The *Power Receptacle* is used for connecting the TL5.5 to the AC power from a wall outlet using the power cord.
- ➔ The *Main Fuse Holder* contains the main power fuse. CAUTION: Replace fuses only with fuses of same type and rating.
- ➔ The *Power Rocker* powers the unit into standby mode. Press up for on and down for off.
- ➔ The *Trigger Outputs* provide a 12V DC signal to external components that are to remotely power up after the preamplifier is operational. Connect the power amplifiers' trigger inputs to the TL5.5's *Trigger Outputs* to remotely power the amplifier(s) on and off.
- ➔ The *Information label* contains Serial number, AC voltage setting and power consumption information.
- ➔ The *RCA and XLR Input Jacks*.
 - 2 pairs of single-ended/balanced line inputs to connect source components to the preamplifier section of the TL5.5, including CD, Aux 1.
 - 5 single-ended RCA inputs Ph/Aux 2, Aux 3, Tuner, Aux 4 and Aux 5
 - 1 pair of single ended RCA Tape input
- ➔ The *RCA and XLR Output Jacks*.



1 pairs single ended and 1 pair balanced Main Outputs

➔ 1 pair of fixed single ended buffered record out

The Remote Control Hand-held Unit

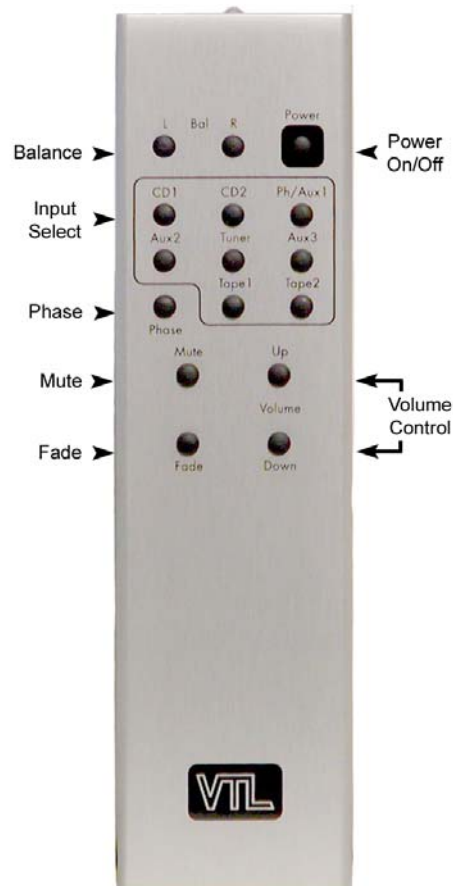

Fig 3. Remote Control Unit

The Remote Control hand held unit supplied with this preamplifier allows the user to perform the following functions:

- Power the preamplifier on and off. This is a toggle control, which changes the state from one to the other each time it is pressed.
- Set the left and right channel balance offset
- Select any of the 8 inputs directly

- Set the preamp between phase inverting and phase correct mode by pressing the phase button. This is a toggle control, which changes the state from one to the other each time it is pressed.
- Increase/decrease the volume by pressing the up and down buttons respectively on the remote control hand-held unit.
- Set/reset the system in mute and operating modes by pressing the mute button on the remote control hand-held unit. This is a toggle control, which changes the state from one to the other each time it is pressed.

If the system is in mute, pressing the volume up button to increase the volume will reset the system and put it into operating mode. The volume down button will not impact the mute state.

- Set the volume down from a higher volume to 20 by pressing the Fade button

When the user first presses any of the buttons on the remote control unit, there may be a short delay before the preamplifier completes the processing of the signal sent by the remote, especially if the line of sight to the preamp is not clear, or if there is any sort of light interference with the infra red signal. The preamplifier will not respond to pressing two buttons at one time, and will only accept the first signal received.

In addition, the remote wand can be used to program another universal remote that can be used in place of or in addition to the supplied remote wand. There are additional discrete remote codes available that are programmed into the preamplifier to replace the three toggle commands that are used on the supplied remote wand: Power on, Power off, Mute on, Mute off, phase correct and phase invert. These codes are either accessed from inside the supplied remote wand by your dealer's installer, or the codes can be sent separately to your dealer in files specially formatted for programming either a Crestron, AMX or Pronto external remote system.

There is also a separate RS-232 port on the back of the preamplifier's chassis that can accept any of the commands required to control the preamplifier remotely, and outputs messages as the front panel controls on the TL5.5 SERIES II are changed. This RS-232 port can be used for a central remote command system.

Fitting the Batteries to the Remote Control

1. Two Phillips head screws hold the back cover on the remote control. Remove all screws with the correct tool to avoid damaging them (using #1 Phillips head screwdriver), and put them aside for later re-installation.
2. Turn the remote control over so that the cover drops into your other hand, and put the cover aside with the screws. Be careful of the inside edges of the remote, as they can be sharp.

3. Locate the battery holder and insert two AAA batteries in the marked positions, + to + and - to -.
4. Being careful not to damage the cover of the remote shell, replace the back cover and snap it into its exact position. Replace the mounting screws, being careful not to over-tighten them, and the cover will settle into place.

Test the remote control functions and ensure that all the functions are working correctly. If the functions are not working then check that the batteries are in the correct mounting positions and that they are not stale. If you still encounter problems then you should contact the factory or your VTL dealer.

Voltage Setting

Your VTL TL5.5 preamplifier has already been set to the correct voltage for your country where you made your purchase, and the voltage setting is marked on the Serial Number Badge located on the back panel of your TL5.5.



➔Caution: Check to make sure that the voltage setting on your TL5.5 is correct for your local voltage rating before plugging in and turning on your TL5.5.

Power Source for the VTL TL-5.5 Preamplifier

Your TL-5.5 Preamplifier is a high-performance component, capable of extremely high resolution and sonic performance. To assure best conditions for optimal results, plug the unit directly into a wall AC outlet. Do not plug your TL-5.5 into a light extension cord or into the back of another component, as this will starve the TL-5.5 of current and significantly impact the performance of your system.

See the chapter on Specifications for the power consumption requirements of your TL-5.5.

Using the supplied power cable, connect the preamplifier to the AC line. For electrical safety, ensure that the AC connector fits securely both to the AC line and to the preamplifier, as a loose connection could cause intermittent operation and may damage the unit.



Warning: Under no circumstances should any attempt be made to circumvent the ground system to the AC line for any reason. Using a ground lifted system can be potentially extremely dangerous, both to persons that might come in contact with the unit, and to the unit itself, and proper RF shielding cannot be attained without a secure ground connection.

Damage to the unit that is the result of improper AC connection or grounding will not be covered under the warranty.

Connecting the Preamplifier to your system

Connecting to a Turntable

You can connect your TL-5.5 preamplifier to the turntable if the unit comes with the internal optional phono stage. Please check the preamplifier by looking down through the slots on the top cover and see if there is a PC board mounted on the left side of the bottom chassis. If this PC board is there, then the unit is equipped with the phono stage.

Select and Connect Source Components

The Input Selection buttons for the preamplifier are marked for *CD*, *Aux 1*, *Ph/Aux 2*, *Aux 3*, *Tuner*, *Aux 4* and *Aux 5* and *Tape*. The input connectors on the back panel of the preamplifier are correspondingly marked the same way.

You can replace and use any of the marked input sources with your own source component as long as the proper interconnect is used. For example, if you do not have a tuner in your system, but you would like to connect any other line level source to the *Tuner* input instead, you can do so without any loss of performance. When you select the preamplifier's input selector to *Tuner* the preamplifier will play the signal from that source.

If your preamplifier is equipped with the Phono option, please use the *Ph/Aux 2* input as the source from your analog system via the turntable. If Phono option is not installed, the *Aux* inputs can be used for any line level input source you wish to use. If your preamplifier is not going to be used with a phono preamplifier then you can also use *Phono/Aux2* as an additional input for any line level source you wish to use.

Connect all source components (e.g. CD, SACD/DVD Audio, Tuner, DAT, Video Recorder etc.) to the inputs on the preamplifier. Before making any connections to the preamplifier make sure that the preamplifier and the source components are powered off. Connect the output cables from each of the source components to the relevant inputs on the preamplifier. For example, connect the CD transport to the CD input connectors of the preamplifier.

Different sources may provide either balanced or single ended connections, and different sources will most likely sound different in each mode. There are 2 balanced or single ended inputs on the TL5.5 preamplifier, and 5 additional inputs that are single ended only, in addition to the 1 single ended Tape input. Decide which source component will be connected to each input, using appropriate interconnects for the different sources

If a direction indicator is printed on the cable make sure that the cable is connected to the source and the preamplifier in the appropriate direction (arrows flowing in the direction the signal will travel, i.e. from the source to the preamplifier.) It is also important that the left and right channels from the source components are connected to the corresponding left and right channels of the preamplifier.

Connect the Phono stage to the preamplifier. If your preamplifier is going to be used with a standalone phono preamplifier, connect the output from the phono stage to the *Phono/Aux 2* input channel of the preamplifier.

Connecting to a Turntable

If your TL5.5 Series II preamplifier is equipped with the optional internal Phono Stage, you can connect the Phono/Aux 2 input of the preamplifier to the cables from your turntable. If a direction indicator is printed on the cable make sure that the cable is connected to the source and the Phono Stage in the appropriate direction (arrows flowing in the direction the signal will travel, i.e. from the source to the phono stage.) It is also important that the left and right channels from the source components are connected to the corresponding left and right channels of the Phono/Aux 2 input. Also connect the Ground wire from your turntable arm to the Ground pin on the back of the TL5.5 II preamplifier.

Connect the Tape input channels to the preamplifier. To take advantage of the Tape Monitor capability of the preamplifier, connect the *Tape In* on the tape deck(s) to the *Record Out* connectors on the preamplifier, in addition to connecting the *Tape* connectors on the preamplifier to the *Line Out* connectors on your tape deck(s). For later identification and monitoring of the taped source, it is strongly advised to connect the primary tape deck to Tape In

Connect the Surround Sound Processor to the preamplifier. To take advantage of the processor unity gain loop capability, connect the Front Left and Right outputs of your home theater preamplifier processor to the left and right channels of any input on the preamplifier, and set that input for Unity Gain by holding the Mon/Proc button and pressing the button for that input simultaneously. Please refer to the programming instructions in the Programming section of this manual for more details on how to set Unity Gain.

Connect the power amplifier to the output of the preamplifier. Before making any connection to the power amplifier make sure that the power amplifier is completely powered down. Any connection to a power amplifier that is powered up can result in damage to the power amplifier and to rest of the system, and/or a loud hum from the loudspeakers.

The interconnect cable between the amplifier and the preamplifier links the left and right input channels of the power amplifier to the left and right outputs of the preamplifier.

The ultra low output impedance of the preamplifier is easily capable of supporting long interconnects up to 35 feet or longer, and can also easily drive any amplifier (and sub woofer) or cable load.

There are one set of RCA output connectors and one set of balanced output connectors available from the preamplifier, and all are operational at the same time. You can connect your amplifier(s) to the preamplifier using either balanced cables or RCA cables.

Although the preamplifier can easily drive extremely low impedances, please be aware that the single-ended output of the TL5.5 preamplifier is 6dB lower in gain than the balanced output. If you have any questions about this then you should contact either your dealer or the manufacturers of your amplifiers, or contact the VTL factory customer service department.

Connecting the TL5.5 to a Home Theater System

Your VTL TL5.5 preamplifier is designed to work in conjunction with both conventional two-channel and home theater systems. If you have both systems set up so that your front speakers are used for your audio as well as home theater systems, then connect the external surround processor front left and right main outputs to any of the preamplifier's inputs. This will allow the surround processor to drive the front left and right speakers when the unity input is engaged.

Under this configuration, when you are listening to your two-channel audio system from sources connected to the line inputs of the TL5.5 then select the relevant input. The source components and the TL5.5 are now driving the front speakers, giving you the full volume control and source selection.

When you want to use your system for home theater, select the input that has been set for unity (see the appropriate section for instructions on how to set an input to unity gain).

Under this configuration the TL5.5 receives the external surround processor's signal for the front left and right channels directly from the external surround processor, and passes it directly to the power amplifiers at the same level that the Processor is putting out. This means that in this mode the volume control is fixed, and the signal is passed to the front left and right amplifiers at unity gain through the gain stage. This gives the external surround processor the volume control of these channels while controlling the center, rear and subwoofer channels at the same time.

Caution: Before unmuting the preamplifier after selecting the unity position, ensure that you adjust the volume of the surround processor to a low level to protect your system from high signals that might result.

Caution: If you do not have a surround processor connected to the TL5.5's unity input, you may get a slight buzzing sound when you select the unity position, which comes from the open input of the power amplifier. This slight buzz will not damage anything in your system, but should be corrected by terminating the input properly.

Using the TL-5.5 to trigger other devices

The TL-5.5 offers two trigger outputs that, if programmed, will supply a low current 12V hold while the unit is powered on. (See separate section on programming one or both of the trigger outputs.)

The connector used to connect to the trigger output of the TL-5.5 is a Phoenix connector, p/n 1792757, and fits into the mating header (Phoenix p/n 1872460) on the rear apron of the TL-5.5. The connector only plugs in one way, so it is polarized.

Your authorized VTL dealer can supply the connector, and make up the correct cable for triggering other devices in your system (usually power amplifier(s)), which will be a custom length, and will include the correct connector for the device to be triggered.

The dimensions of the connector, in mm are:-

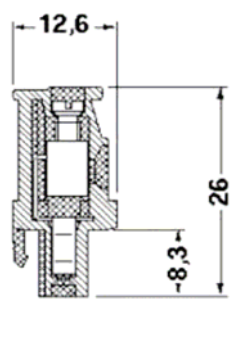

The polarity of the trigger voltage is positive + on the pin closest to you with the side view shown above, and in the photo below positive is the closest left-most screw-terminal pin, with negative – to the right of that (note that the locator pin shown on the left of the diagram above is on the far side of the photo).

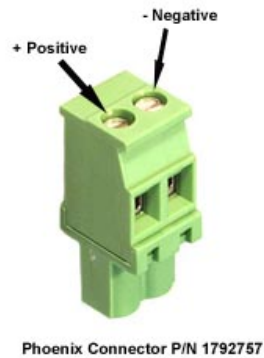

Note that the device being triggered should not place a high electrical load on the trigger output of the TL-5.5

Operating the Preamplifier

Powering your preamplifier and the rest of your system on

After you have properly connected all your source and amplifier components to the preamplifier you are ready to power your system on.

1. If you haven't already done so, ensure that both the tubes inside the preamplifier are properly seated all the way into their sockets before powering the unit from the AC source. Look through the cooling slots on top of the audio chassis in the front half of the circuit board. If the tubes are not fully seated into their sockets, then disconnect the unit from the AC, and from the rest of the system. Locate the section on Tube Replacement in Chapter 4 of this manual and follow the instructions to remove the cover and reseat the tubes.
2. If the tubes are fully seated then power on the source component(s) you intend to use for your listening session.
3. From the preamplifier's front panel Power On switch turn on the preamplifier. When you first power-on your preamplifier it goes through a warm-up stage that takes approximately 90 seconds, with countdown status displayed on the front panel numeric display window. During this warm-up period the preamplifier is in the muted mode. After the warm-up stage is completed, the preamplifier automatically goes into the operating state at 00 volume. The power LED on the unit turns into a steady blue light, indicating that the preamplifier is ready for use.

Check to make sure that the unit's status display indicates preamplifier warm up mode, as indicated by the blinking power LED and a countdown timer display counting from 90 (seconds), decrementing in 1 second steps.

4. Once the preamplifier completes its warm up cycle the Power LED will stop blinking to indicate that it has changed from the warm up state into the operating state.

In case the status display does not behave as described check to make sure that the power cable is securely connected to the AC Power connector on the back panel of the preamplifier, and the power cable is securely plugged into the AC supply, with the AC ground securely connected to the ground of the AC supply.

Contact your VTL dealer if the unit still will not power up after these checks have been performed.

5. Check to ensure that the inputs are correctly configured for the preferred mode of connection for each of the sources in either balanced or single-ended mode. **Inputs CD and Aux 1 are set to balanced by default.** If you wish to set the selected input to single-ended, hold down the button for that input for three seconds. The LED for this input will now change from blue to green to indicate that the input has been changed to single-ended. Note that only the first two inputs can be configured for either balanced or single ended use, and all others are single ended only.
6. Press the Input Selector to the input source you would like to use.
7. If not connected to the triggers, turn on the power amplifier(s) in your system.
8. Set the source component to play mode.
9. Turn the volume control up to the desired playing level, by either turning the Volume Control knob clockwise or the volume up button on the remote control. If the preamplifier is in mute, (i.e. the Mute LED is flashing), either push the mute button to reset the system out of mute and into operating mode, or raise the volume control, either via the front panel knob or the remote control, to release the mute.
10. The LEDs on the unit's front panel indicate the operating mode of the preamplifier. For more details on the different operating modes indicated by the LEDs, please refer to the section below on "Operating modes and LED Indications":

Ground Loop Hum

If you get a ground loop hum from your stereo system after installation and power up you should immediately turn off the TL5.5 and consult your VTL dealer or the VTL factory.



Caution: Under no circumstances should you attempt to lift or defeat any grounds on electrical equipment plugged into the AC, as these grounds are installed for your and the equipment's safety, and an ungrounded component can present an extremely hazardous condition and is illegal under most electrical safety codes. For your own safety please refer all questions of this nature to a properly trained service technician

Using the Preamplifier with the Remote Control

1. If not already done, open the back of the remote control by removing the two Phillips head screws and gently shaking the back cover off the remote unit. Locate the battery holder and install the two AAA batteries supplied in the correct directions as marked in the battery holder, with plus on each battery corresponding with the plus sign in the holder. Replace the back cover of the remote and re-install the screws. (Fit the battery as shown in the instruction.)
2. The system can be powered on and off with the power button on the remote control.

3. Use the remote control wand's source buttons to select the desired source.
4. Use the remote control's volume button to adjust the desired playing level. Increase the volume by pressing the up button on the remote control, and decrease the volume by pressing the down button on the remote control.
5. If the system is in mute, (i.e. the Mute LED on the preamplifier's front panel is flashing), press the mute button on the remote control to take the system out of mute mode and put it into operate mode. Pressing the volume up button on the remote control unit will also reset the system out of mute mode. Note that pressing the volume down button on the remote will not affect the Mute/operating state of the preamplifier.
6. Use the phase button on the remote unit to toggle the phase status of the system. If the system is in phase correct mode, click the Phase button once to put it into phase inverted mode. The Phase LED will turn from off to red when the system is changed to phase invert.
7. Use the remote control's Left Balance and Right Balance buttons to set the channel balance status of the preamplifier. Pressing the Left or right Balance buttons will signal the preamplifier to go into channel balance adjustment mode. The numeric display window displays a bar on the left of the numeric display when the Left Balance button is pressed, and a bar to the right of the display when the Right Balance button is pressed. The numeric display also shows the channel imbalance offset value.
8. Use the Fade button on the remote control to change the volume level down to 20 if the current level is higher than 20. The Fade button acts as a shortcut to allow you to quickly turn down the volume of the preamp to level 20. If the current level is below 20, then pressing the Fade button has no effect.

Using the Tape Loop to monitor recordings

The TL5.5 has two separate tape inputs, a monitor function, and a tape dubbing system designed into the control hardware and software. These controls will prevent the possibility of howl from tape loop feedback between the tape inputs and the record outputs.

If you use a tape deck that gives you the capability of monitoring the recording, i.e. listening to the recording while it is taking place, you can use the TL5.5's Tape Loop function to take advantage of this feature. Connect the tape's input and output cables to the TL5.5's Rec Out and Tape In connectors, respectively, as per the instructions in the *Getting Started* section of this manual. While the tape deck is in recording mode, set the preamplifier to monitor mode by pressing *Tape* button on the front panel while holding the *Mon/Proc* button.. This allows the preamplifier to play back the recording simultaneously while the tape is recording the selected source. In this mode the volume of the Tape monitor input is regulated by the main volume control on the TL5.5.

Caution: Before engaging the Tape monitor switch be sure to turn the volume control all the way down to 00.

Connecting to the Turntable

If your TL-5.5 Series II Preamplifier is equipped with the optional internal phono stage, you can use the phono stage with either MM or MC cartridge. The VTL factory standardly configures the TL-5.5 II phono stage to work with a MC cartridge and with the following standard settings:

1. MC input selected (MC CON jumper in)
2. Gain = 66dB
3. MC Load = 1K Ohm
4. Standard RIAA

If you would like to alter the standard setting, please follow the instructions in the Addendum section or contact your dealer for assistance.

Operating Modes and Factory Default Settings

Powering the TL5.5 off from the front panel or remote wand will save all of the existing settings to memory for use at a later power up. Loss of power before the settings are saved will cause the settings to be lost from memory, and the preamplifier will have to be programmed again and the settings saved by powering down from the front panel or remote power buttons. Powering down from the rear rocker switch has the same effect as loss of power, and does not save settings to memory.

Function	Default Mode	Indication
Suppress timer countdown	Not set	Timer decrements
Trigger output	None set	None
Inputs CD, AUX1 (Defaults to input CD selected)	Balanced mode	Selected input LED color is blue
Volume setting	Zero volume	0 on numeric display
Mute	Not selected	Mute LED off
Input level offsets	Not set	None
Phase	Phase correct	Phase LED off
Channel Balance	Not selected, no imbalance	Bal LED off
Unity Gain input	Not set	None

Tape Monitor	Not set	Mon/Proc LED off
Suppress Out of Balance display	Not set	None
Programming Lock Out	Not set	None

Quick Reference: Special Programming Functions

Function	Programming Sequence
Enable Trigger Output: To set up to 2 Trigger outputs to remotely turn on your system components that can accept the 12V turn-on.	During the power up 90 to 0 countdown sequence, user holds down any of Input 1 thru 2 buttons, i.e. CD, AUX 1 (for trigger 1 through 2). To set trigger timer, user rotates control knob clockwise to 99 maximum (to increase trigger time) or counter-clockwise to 01 minimum (to decrease trigger time). No two triggers can be set for the same turn on time - numerical display skips already selected trigger times.
Disable Trigger Output	To undo the Trigger timer, during 90 to 0 power up sequence, hold the button for the Trigger output and rotate the volume control counter-clockwise until numerical display shows OF.
Suppress Power on Countdown timer	If you do not wish to see the 90 to 0 countdown when the preamp goes through the power up sequence, you can suppress the display by pressing the Mute button during the countdown sequence. Any programmed trigger indication will be suppressed also.
Set input to Unity Gain (for any input CD... Aux 5)	While the preamp is in operate mode, select the input you wish to set to Unity Gain. Then hold the Mon/Proc button and at the same time press the input button again. The numeric display changes to UI to indicate that Unity Gain is set, and the Mute LED blinks.
Remove Unity Gain setting from an input	While the preamp is in operate mode, select the input that you wish to reset the Unity Gain. Note the Mute LED blinks. Hold down the Mon/Proc button first and then press the input again. The numeric display changes to indicate the volume for that input prior to setting Unity Gain.
Set Input Level Offset: Input offsets are used for equalizing volume gain levels between different inputs that have different output levels,	While the preamp is in operate mode, hold the button of the input you wish to set the Offset, and rotate the volume control knob at the same time.

so that when an input is selected the overall volume of the system will not change.	The numeric display will now indicate the Offset value that you wish to set. Release the input button to complete the setting. To remove Input level Offset, hold the input button down and turn the volume control counterclockwise until numeric display indicates 00.
View Input Level Offset: (In Lock Out Mode only)	Hold the Input button and the numeric display will indicate the Offset value.
Suppress Out-of-Balance display	Hold the Balance button and press the Mute button.
Re-enable the Out-of-Balance display	Hold the Balance button and press the Mute button again.
Disable Input: Disabled inputs cannot be selected and used in any way after being disabled.	While the preamp is in Power-on mode, select the input you wish to disable and hold down the Mute button at the same time.
Re-enable Input: To re-enable the input.	While the preamp is in Power-on mode, select the input you wish to re-enable and hold down the Mute button at the same time.
Programming Lock Out Mode: Setting and resetting of Triggers, Unity Gain, Balanced or Single-ended mode for any input, and input Offset are all disabled.	This setting is done during Power down cycle only. Hold the Mon/Proc button and press the Power button on the front panel and release the MON/Proc button after pressing the Power button.
Restore Programming Mode: Remove the Lock out mode to enable Trigger, Unity Gain, Balanced/Single-ended selection, and Input Offset.	This setting is done during Power up cycle only. Hold the Mon/Proc button and press the Power button on the front panel, and release the MON/Proc button after pressing the Power button.

LED Indications

Power LED:

When the unit is powered on by pressing the *Power* button on the front panel, the LED light will be lit. When the unit is powered off, the LED lights are turned off.

Blink blue during Power up sequence and the trigger sequence.

Remain steady blue after power up and trigger sequence.

Inputs 1 & 2 LED (CD, Aux 1)

During Power up sequence, these LEDs will blink RED if that trigger (either inputs 1 and 2) is programmed, else no LED is lit.

During trigger sequence, blink red until trigger activates, then steady red while other triggers activate, then off after all programmed triggers activated.

After trigger sequence, LED will turn OFF if not selected as input. If selected as input, LED will turn green for single-ended RCA input, blue for balanced XLR input.

Input 3 LED (Phono/Aux 2)

After power up sequence, LED will turn OFF if not selected as input. If selected as input, LED will turn green for single-ended RCA input. If the preamplifier is equipped with the internal phono stage, holding the Phono/Aux 2 input for over 5 seconds will enable the Rumble Filter setting and the LED will turn red. To disable Rumble Filter setting, press the Phono/Aux 2 input for another 5 seconds and the LED will turn green.

Inputs 4, 5, 6 and 7 LED (Aux 3, Tuner, Aux4, Aux 5)

Inputs 4, 5, 6 and 7 are for single-ended inputs only. During Power up and trigger sequence, these LEDs are not lit.

After trigger sequence, LED will stay OFF if not selected as input. If selected as input, LED will turn green for RCA input.

Tape

During Power up and trigger sequence, LED is not lit.

After power up and trigger sequence, if Tape is selected as input, LED will turn green.

If Tape monitor is selected after power up and trigger sequence, LED will turn red.

Tape monitor will be dropped if different input is selected, and will not return after power down and re-power up.

Mon/Proc LED

During Power up and trigger sequence, no LED.

After power up and trigger sequence, lights red if monitor function selected.

Phase LED

During Power up sequence, no LED.

After power up and trigger sequence, LED off for Phase correct and red for Phase inverting.

Channel Balance LED

During Power up and trigger sequence, no LED.

After power up and trigger sequence, LED will light blue if channel balance function is selected.

Mute LED

When the unit is in mute the LED light blinks steadily. When the unit is in normal operating mode, the mute LED light is off.

During Power up and trigger sequence, the LED is not lit.

After power up and trigger sequence, LED will blink red if Mute button is pressed. When the mute button is pressed again, the mute LED is turned off.

Numeric Display

Blue three-digit 7-segment display. Indicates volume setting of unit, (if not set to turn off automatically - if set to turn off, display will return with any command sent to the preamplifier, and then turn off again after the programmed time (from 0 to 90 (seconds)). Indicates countdown sequence timer display for power on when unit is turned on (and countdown display is not suppressed). Indicates trigger timing during trigger programming, and balance or out of balance information. If the channels are out of balance, out-of-balance indicator on left (for leftward balance) or on right (if rightward balance) of numeric display is visible during operate mode (if the balance display is not suppressed). If the balance display is suppressed, then the indicators are only lit when accessing balance function. Indicates input offset, with bar on left of numerals for negative offset, and positive value for a positive offset.

Programming the Preamplifier's function controls

The TL5.5 Signature Line Preamplifier is a sophisticated unit with a wide array of user features and controls. It is strongly advised that you read and understand these instructions to get the most out of your new purchase.

Logical Sequence of Events, and possible programming operations during that event

1. Powered off Mode

The unit may need to be completely de-powered, during a long absence, or during a storm to prevent damage from lightning strike.

User input: AC power is connected to the unit and unit is switched off at rear rocker power switch, or AC power is not connected.

Indication: No display is lit.

Status: The unit is completely off and cannot be turned on via any front panel or remote command.

2. Stand-by Mode

Unit is left in standby and waiting power up command when not operated. No circuits are running, except logic circuit to power control microprocessor.

User input: AC power is connected to the preamp and rear rocker switch is switched to ON position.

Indication: The numeric display displays a steady double-dash.

Status: Processor waits for power on command from either front panel, remote control wand, or discrete remote command from external remote (Crestron or AMX) via rear RS-232 port.

3. Power up mode (Remote control or front panel)

Unit is required for use.

User input: Unit is in standby mode and user presses the Power button, either on the front panel or the remote control, or sends a discrete power on signal from external remote.

Indication: The power-on LED on the unit blinks to indicate that the power on sequence is being executed. At the same time, (if not suppressed by user) the numeric display goes into the sequential countdown timer from 90 to 0. If power on sequence is successfully executed, display on unit indicates that it is no longer in standby mode when the numeric display changes to 0.

When the unit has completed the power-up sequence, the numeric display changes to volume indicator to indicate that unit is now ready to play, and the volume readout shows 0. The front panel LED for last input selected is lit, and power LED is steady blue.

Status: Unit is in zero volume mute mode, last used input is selected, balanced/single-ended mode and unity gain processor loop settings for all inputs are restored. The last phase setting and channel balance since the last power-off are also restored. The unit is ready to go into play mode after the user increments the volume.

4. User unlocks Programming Lockout (During power-up only) (Front panel or RS-232 port)

Programming lockout is to lock all programming functions so that they are not able to be accidentally re-set to some unintended setting during normal operation. (To make a system change requiring re-programming, lockout is unlocked and then re-locked after making the change.)

- User input: During the preamp's power up cycle, the user presses front panel Power On button while holding Mon/Proc button down. Addressable through RS-232 port also – see specific section for command structure.
- Indication: No indication.
- Status: Unit allows all programming functions (Triggers, trigger timing, Unity gain, input mode, input disable or enable, and input offset) while unlocked.

5. User suppresses (or enables) power-on countdown timer indicator (During power-up only) (Front panel or RS-232 port)

Countdown timer displays number of seconds until ready during power up warmup sequence.

- User input: During the preamp's power up cycle, user presses the Mute switch, or enters command via RS-232 port. Addressable through RS-232 port also – see specific section for command structure.
- Indication: Countdown timer display toggles between display and suppress display with each press of the Mute button during power on warm-up cycle. If the countdown is currently displayed Power-on countdown display is turned off when mute button is pressed, and countdown display timer is returned if the mute switch is pressed again during the power-on cycle.
- Status: Power-on countdown mode is turned on and off depending on the current state. (Remote control mute button does not change the power-on countdown display.)

6. User changes trigger output turn-on time (During power-up only) (Front panel or RS-232 port) (Unlocked mode only)

Triggers are used to remotely power on other components in the system, such as power amplifiers, which are turned on after the preamplifier is warmed up. Trigger outputs are typically 12 Volt systems, connected via hardwired connection between components. Triggers typically perform a hold function: when power is released the remotely powered component automatically powers down.

- User input: User holds down either of Input 1 or 2 buttons (for trigger 1 or 2). To set trigger timer, user rotates control knob clockwise to 99 maximum (to increase trigger time) or counter-clockwise to 01 minimum (to decrease trigger time). Rotating volume control counter-clockwise until numerical display shows 0F turns off selected trigger. Addressable through RS-232 port also – see specific section for command structure.

No two triggers can be set for the same turn on time - numerical display skips already selected trigger times.

Indication: Except for setup via the RS-232 port, the numeric display changes from incremental timer count (if not suppressed) to steady numerical display indicating time at which trigger output will turn on after power-up cycle is completed. Triggers that are programmed off will not light trigger LEDs. Trigger outputs that are programmed will blink input LEDs red during power-up cycle before turning on each selected trigger. Countdown begins again at 90 seconds after each trigger program command, (except for setup via the RS-232 port), and shows on the display (if countdown is not suppressed.)

After the input trigger is activated, the LED stops blinking and remains lit. After all triggers have been activated all red front panel trigger LEDs turn off and release indicator status to input select indicate mode. The power-on LED continues to blink during the entire trigger sequence, and then stays lit when the triggers are completed. If there is no reaction then the unit is in lockout mode and must be unlocked before setting (except for setup via the RS-232 port).

Status: Unit is in muted power-up mode and trigger outputs will turn on at selected time after power-up cycle. If there is no reaction then the unit is in lockout mode and no change is made.

7. User changes input setting from single-ended mode to balanced mode (Input 1–2 only)(Front panel or RS-232 port) (Unlocked mode only)

Most components are single ended, but balanced operation is often quieter and more dynamic. Balanced operation requires a different connector than standard single ended operation.

Warning **It is critical for proper sonic performance of this component that it be properly configured for the correct mode of operation. If a balanced signal is applied to the inputs the unit must be configured for balanced operation, and vice-versa.**



User input: User holds down the input selector button for input to be changed to single ended or balanced mode. Addressable through RS-232 port also – see specific section for command structure.

Indication: If user holds an input 1- 2 button down for 3 seconds, the input mode for that selection toggles between balanced and single ended mode, and the LED for the mode selection on that input changes between green single ended RCA input and blue balanced XLR input. If there is no reaction then the unit is in lockout mode and must be unlocked before setting.

Status: If unit is not in lockout mode then balanced or single ended mode for that input is activated. If there is no reaction then the unit is in lockout mode and no change is made.

8. User disables inputs (Front Panel or RS-232 port) (Unlocked mode only)

Inputs that are not connected to a source should be disabled to prevent noise in the system whenever an unconnected input is accidentally selected.

User input:	While unit is powered up user presses the selected input button on the front panel while holding down the Mute button. Addressable through RS-232 port also – see specific section for command structure.
Indication:	The blanked input LED goes out, and no input is set until any other input is selected, and thereafter the blanked input is unable to be selected until it is re-enabled. If there is no reaction then the unit is in lockout mode and must be unlocked before setting.
Status:	The blanked input is unselected and unit is in Mute mode until another input is selected. Blanked input does not react to any further selection, offset, unity or mode change attempts. If there is no reaction then the unit is in lockout mode and no change is made.

9. User programs input level offsets (Front Panel or RS-232 port) (Unlocked mode only)

Input offsets are used for equalizing volume gain levels between different inputs that have different output levels, so that when an input is selected the overall volume of the system will not change.

User input:	For each individual input to be changed, and with unit in operate mode (ie not during warm up cycle) user holds down input select button and rotates volume control, counter-clockwise for lowering input level offset, and clockwise for increasing input level offset. Releasing the input button returns the volume display to show the level it was before the input offset was programmed. If muted then mute releases on volume up or down, to show effect of offset. Addressable through RS-232 port also – see specific section for command structure.
Indication:	Volume display changes to display that input offset level while input button is held down. If offset level is at 00 and volume control is rotated counter clockwise then display shows a – in front of the two-digit display while input button is held down. Rotating volume control clockwise from 00 shows a positive number. When the input button is released the volume display returns to show the gain level before the input offset was programmed. If there is no reaction then the unit is in lockout mode and must be unlocked before setting.
Status:	Unit stays in operate mode and adjusts the volume of that input down as the user rotates the volume control. Once user releases the input button the unit remains at the set volume setting (while displaying the setting the unit was at before the input was programmed.) If there is no reaction then the unit is in lockout mode and no change is made.

10. User changes selected input to unity-gain mode (Input 1 – 7 only) (Front Panel or RS-232 port) (Unlocked mode only)

Unity gain is used when there is another unit in the system that in an alternative system configuration (typically multi-channel surround sound) will control gain to the same channels that the preamplifier is controlling in the two-channel system configuration. In this case, to achieve proper system volume balance and make gain adjustment more predictable it is desirable to avoid the need to use two volume controls, and the two channel preamplifier is set to pass signal through to the amplifiers its is connected to without gain or attenuation.

User input: User holds down Mon/Proc button and simultaneously presses the currently selected input button. Addressable through RS-232 port also – see specific section for command structure.

Indication: Volume setting indication changes to UI and mute LED blinks. If user changes the volume control or presses volume up or down button on remote control the volume indicator does not change. If the user selects another input, (whether or not set for unity gain), the mute function turns on and the mute LED blinks, and if the new input is not set for unity gain the unit displays the volume setting. User must explicitly press the mute button to get out of the mute mode, as the volume up does not release mute.

If there is no reaction to the front panel unity command then the unit is in lockout mode and must be unlocked before setting.

Status: Unit is in muted mode and volume does not change from unity gain after user un-mutes unit. Volume, input offset, balance, phase and tape monitor functions are inactive for the unity gain input. Whenever the user selects the input that is in unity gain mode, the mute function is turned on again and the mute LED blinks. User has to explicitly un-mute to use that input. If there is no reaction to the unity command (indicating that the unit is in lockout mode) then no change is made.

12. User changes input selection (Remote or Front Panel)

As a control center, the preamplifier must be able to switch between different source components connected to different inputs.

User input: User selects an input by pressing input button, either on front panel or remote control.

Indication: The LED for the new input is lit and the LED for the previously selected input switches off. The numeric volume display does not change, unless the input selected is programmed as a unity gain pass-through. If the input is set as a unity gain pass through then the display shows UI and the mute LED blinks. If there is no reaction then the input is disabled and must be enabled before selecting.

Status: New input is selected and the previously selected input is de-selected. The numeric volume display does not change, and the actual gain setting is determined by the offset programmed by the user for that input. If the input is set as a unity gain pass through

then the unit goes into Mute mode. If there is no reaction then the input is not selected and the previously selected input stays selected.

13. User toggles between play and mute modes (Remote or Front Panel)

Mute is used to instantly bring the output of the preamplifier to zero level.

User input: User presses the mute button on the front panel or the mute button on the remote control, or sends a discrete mute or unmute signal from external remote.

Indication: The mute LED steadily blinks red in Mute mode, and turns off in Play mode.

Status: The output is muted in Mute mode and unmuted in Play mode. In mute mode rotating volume control counter-clockwise decrements the volume level as indicated by the numeric display and leaves unit muted. Varying volume control clockwise in muted mode un-mutes unit (and raises volume).

14. User changes volume (Remote or Front Panel)

14.1 Front Panel:

The main function for a preamplifier is to attenuate or amplify signal that is fed into it.

User input: User either rotates the volume knob clockwise for volume up, or counter-clockwise for volume down, until desired volume is reached.

Indication: The numeric display continues to display a number to indicate the present volume level. As volume level is changed the front panel display increments sequentially to display the new volume setting. The volume level ranges from 0 to 127.

Status: Volume level is changed and the display increments sequentially to the new volume setting. If unit is in Mute mode then volume up changes unit to Play mode, while volume down keeps unit in Mute mode.

14.2 Remote:

User input: User either holds the volume up button on the remote control for volume up, or holds volume down button on remote control for volume down, until desired volume is reached.

Indication: The numeric display displays a two-digit number to indicate the present volume level. As volume level is changed the front panel display increments sequentially to display the new volume setting. The volume level ranges from 0 to 127.

Status: Volume level is changed and the display increments or decrements sequentially to the new volume setting. If unit is in Mute mode then volume up changes unit to Play mode, while volume down keeps unit in Mute mode.

14. User changes channel balance (Remote or Front Panel)

Changing channel balance is sometimes required where there is uneven signal from left to right, (or vice versa), or an uneven room acoustic, requiring a compensating adjustment to equalize volume level from both channels.

15.1 Front Panel:

User input: User holds the Balance button down and rotates the volume control. Turning the volume control clockwise varies channel balance towards the right channel by lowering the left channel volume. Turning the volume control counter-clockwise varies the balance setting towards the left channel by lowering the right channel volume.

Indication: The LED for the Balance switch turns on and the display panel changes to indicate the channel balance state: If the two channels are balanced, the display changes to double dash, and if out of balance then display changes to display either directional bar in direction of out-of-balance and volume display shows degree of out-of-balance. If the channels are out of balance, when the display reverts to volume display the directional bar is displayed next to the volume level indication in whichever direction the balance is out of balance, either on left (for leftward balance) or on right (for rightward balance).

A few seconds after the BALANCE button is released the numerical display returns to indicating the volume setting, and depending upon user setting, out-of-balance direction bar is either displayed or suppressed for out-of-balance settings after releasing balance button.

Status: The unit goes into Balance Setting mode when the Balance button is pressed and the display indicates the balance offset value. The Balance LED is lit during balance setting mode.

15.2 Remote:

User input: User holds down either Balance button. Holding down the right button varies channel balance towards the right channel by lowering the left channel volume. Holding down the left button varies the balance setting towards the left channel by lowering the right channel volume.

Indication: The Balance indicator LED on the front panel turns on and the display panel changes to indicate the balance state: If the two channels are balanced, the display shows a double dash. If out of balance then display changes to degree of out-of-balance, and when

the volume display reverts to displaying volume, the directional bar is displayed next to the volume level indication in whichever direction the balance is out of balance, either on left (for leftward balance) or on right (for rightward balance). The balance display remains unchanged for 2 seconds after the Balance button is released, and the display returns to indicating the volume setting.

Status: The unit goes into Balance Setting mode while either the Balance L or the Balance R button is held down or the Balance button is pressed.

16. User toggles between suppressing and displaying out-of-balance display information (Front Panel or RS-232 port)

User may not want to display permanent out of balance conditions all the time.

User input: User presses mute button while holding down balance button. Addressable through RS-232 port also – see specific section for command structure.

Indication: Left or right bar on front panel display toggles between display and no display.

Status: No functional change in unit.

17. User changes absolute phase (Remote or Front Panel)

Absolute phase between positive wave fronts and negative rarefactions of sound (watch the woofer of your loudspeaker on bass notes) varies from recording to recording (and sometimes within different tracks on a recording), sometimes by design, and sometimes in error. High resolution systems are easily able to resolve these anomalies, and the user may wish to correct the problem by changing the phase of the signal.

User input: User depresses Phase button on front panel or remote, or sends a discrete phase or phase reverse signal from external remote.

Indication: The LED for phase toggles between 0° (off) and 180° (red).

Status: The unit changes output polarity with respect to input.

18. User fades signal (remote only) (unmated only)

Fading/lowering the signal quickly (as opposed to muting it to zero level) is sometimes desired, and is faster to lower the volume than the sequential volume control.

User input: User presses Fade button on remote control.

Indication: Volume level indication on front panel jumps directly to 20.

Status: Output volume level drops directly to volume level of 20 (including offset.) If the volume level is less than 20, or if the unit is in Mute mode, pressing the Fade button will not change the level.

19. User monitors input while recording (any input) (Front Panel only)

If the user wants to be able to listen to the recording as it is being made on such an equipped tape deck then the monitor function is used. The selected input being recorded will still be routed to the record output (which is connected to the input on the tape deck), and the output from the tape deck connected to the tape input will become the amplified signal.

User input: User presses the Tape button while holding the Mon/Proc button.

Indication: Tape LED and Mon/Proc LED are lit (red) while selected input stays lit.

Status: Preamp output switches from selected input to selected tape monitor position, while keeping input selected. Volume control continues to be able to be varied, either from front panel or remote control.

20. User locks Front panel Programming Lockout (during power down cycle only) (Front panel or RS-232 port) (Unlocked mode only)

Programming lockout is to lock all programming functions so that they are not able to be accidentally re-set to some unintended setting during normal operation. (To make a system change requiring re-programming, lockout is unlocked and then re-locked after making the change.)

User input: User presses front panel Power button while holding Mon/Proc button down. Addressable through RS-232 port also – see specific section for command structure.

Indication: No indication.

Status: Unit does not allow any programming modes (Triggers, or trigger timing, Unity gain, input mode, input disable or enable, and input offset) while locked

21. User Powers down to Stand-by mode (Front Panel, remote control)

If trigger functions are used to signal the remote power amplifiers to be turned on the preamplifier should not be left powered up when not in use, and power down to standby condition is required to await power on command.

User input: User presses Power button, either on front panel or remote control while the unit is in power-on mode, or sends a discrete power off signal from external remote.

Indication: The display turns to double dash. All other indicators are turned off.

Status: The unit immediately begins power down and releases output relays to closed position. Last used input selection, phase, channel balance unity gain processor loop settings, countdown and balance suppression are all saved in memory for next power-up.

22. User re-powers after power down command (Front panel or remote wand only)

User changes mind on powering down, or powers down accidentally, and does not wish to wait for 90 second power up timer in order to be able to continue operation.

User input: User presses power button on the front panel or the remote control again within 2 seconds of pressing power down. (Does not apply to power down codes sent from external remote.)

Indication: Volume display changes from double dashes to previous volume setting that was displayed when power down command was sent from front panel or remote wand.

Status: Unit un-mutes and returns to volume setting when power off command was sent.

23. User programs external remote with existing codes, plus discrete (extended) codes

Central remote systems require just one remote console to control the whole system. While there is bi-directional communication about the operating status of the TL5.5 preamplifier via the RS-232 port, if using a remote infra red extender there is no bi-directional status information available via infra red connection, and it is required that discrete commands be used by the central remote, so that it does not get out of synch with the preamplifier. The replaced commands are the toggle commands that use the same command to toggle between two opposing states of operation.

User input: Communication of direct remote codes to bypass toggle commands for Crestron, AMX or Pronto. Use standard user wand with temporary internal jumper, for some extra codes from 4 extra positions on remote key matrix (Mute ON, Mute OFF and Power ON and Power OFF), or a dedicated programming remote wand that provides all remote codes via I/R (containing alternate processor chip with toggle commands deleted and changed to Power (ON), Mute (ON) Phase (ON), and temporary internal jumper for Power OFF, Mute OFF and Phase OFF) and output to either Crestron, AMX or Pronto program file.

Indication: As per Power, Mute and Phase.

Status: As per Power, Mute and Phase. Unit reacts to additional direct commands from external remote source via rear mounted IR receiver, in addition to toggle commands as above.

Using the preamplifier with RS232 control

This preamplifier comes with sophisticated bi-directional control and communication capabilities, where all of the control and query functions can be performed remotely, and the preamplifier's status information is communicated by its main microprocessor.

The preamplifier also communicates via the RS-232 port any changes made via the front panel or remote wand, using what is called 'event generation', to keep other connected components in synch with the TL-5.5.

Control functions and information returned are accessed through the rear RS-232 port via a standard DB9 male female connector cable and standard ASCII text strings using pre-defined commands as listed below in the summary of all the control functions that can be performed on the front panel and the expected results on the RS-232 port.

The RS232 communication port is designed to interface with central command systems to enable the preamplifier to be located and operated remotely, and allows the user to interface with the preamplifier using any PC and the standard HyperTerminal utility provided with the Microsoft Windows Operating system. Hyperterminal is configured using the Properties command under the File menu with the following settings:

9600 Baud, 8 data bits, Parity =None, 1 stop bit, Flow control =None

While the Hyperterminal window is still opened, select the File menu and click on the "Properties" command.

Check that the "Connect To" tab specifies "Connect Using" as COM1.

Change to the "Settings" tab, check the following settings:

First field: Function, arrow and ctrl keys act as – "Terminal Keys" selected

Second field: Backspace key sends – Ctrl+H selected

Third field: Emulation – Auto Detect selected

Fourth field: Telnet terminal ID: ANSI

Fifth field: Backscroll buffer lines : 500

Push the ASCII Setup... button and ASCII Setup dialog box opens.

ASCII Sending section:

Do not select "Send line ends with line feeds"

Do not select "Echo typed characters locally"

Line Delay – 0

Character Delay – 0

ASCII Receiving section:

Select "Append line feeds to incoming line ends" – check mark on this field

Deselect or uncheck "Force incoming data..."

Deselect or uncheck "Wrap lines that exceed..."

Close the ASCII Setup dialog box by clicking the OK button.

Close the Siegfried Hyperterminal Properties box by clicking the OK button.

Save the Hyperterminal settings before you close the Hyperterminal window.

After the Hyper terminal Program is running and its window is opened, enter the text string >HELP (or >?) followed by carriage return to display available commands for the TL5.5 preamplifier. The convention used is command {parameter} or command [parameter], with {} meaning required parameters and [] meaning optional parameters. For systems without a return button the amplifier's microprocessor recognizes /C as a

carriage return, and /R as a return. The input and output buffers of the TL5.5 SERIES II can hold a maximum of 256 bytes at one time.

The available RS-232 user commands are:

Command	Meaning / Use	Expected response
>HELP or >?	For displaying a list of all available commands	All commands and their syntax. >ENTER COMMAND: (input={CD AUX1 PHAUX2 AUX3 TUN AUX4 AUX5 TAPE}) > BALANCE [{L R + -}n], BALANCED [input][ON OFF], COUNTDN [ON OFF], > DSPLYOFF [n], DISABLE [input], ENABLE [input], FADE, INPUT [input], > HELP, LOCKOUT [ON OFF], MUTE [ON OFF], OFFSET [[+ -]n], PHASE [0 180], > POWER [ON OFF], STATUS, TRIGGER, UNITY [input][ON OFF], VERSION, > VOLUME [[+ -]n], VTL
>STATUS	For querying the status of the preamplifier	Returns current status as set, for example: >STATUS: POWER ON, INPUT CD, VOLUME 0, PHASE 0, OFFSET 0, UNITY GAIN OFF, BALANCED
>POWER {ON OFF}	For powering the preamplifier ON and OFF	Returns current power status. >STANDBY for > POWER OFF command >TURNON SEQUENCE STARTED for >POWER ON command, with >TURNON SEQUENCE FINISHED for completed power up sequence.
>MUTE {ON OFF}	For muting and unmuting the preamplifier	Returns current mute status.
>VOLUME [[+ -]n]	For raising or lowering volume, or going directly to a particular volume setting.	Raises (or lowers) the volume in single step increments (or decrements) and outputs the new volume setting to the RS-232 port
>INPUT [input] (input={CD AU	For changing the active input.	Returns current active input.

X1 PHAUX2 AUX3 TUN AUX4 AUX5 TAPE})	input.	
>BALANCE [L R + -}n]	For changing the channel balance, or going directly to a particular channel balance setting.	Changes the channel balance in single step increments (or decrements) and outputs the new balance setting to the RS-232 port
>PHASE [0 180]	For querying or setting the phase setting of the amplifier	Returns current phase setting.
>FADE	For lowering volume settings above 20 directly to 20 in 1 step.	Returns >VOLUME 20
>TRIGGER	For programming triggers 1 and/or 2	Returns current trigger 1 and 2 settings, in seconds after warmup, for example: >TRIGGER 00/00
>BALANCED [input][ON OFF]	For toggling Inputs 1-3 between balanced and single ended mode	Returns current balanced settings, for example: >BALANCED: CD, AUX1
OFFSET [[+ -}n]	For setting input offsets to equalize volume between inputs.	Returns current offset settings for selected input, in degree of offset, for example: >OFFSET -01
>UNITY [input][ON OFF]	For toggling between unity gain settings and normal settings of inputs 1 – 8.	If queried returns current unity inputs, for example: >UNITY GAIN: AUX3 If queried on a particular input returns that input's unity setting, for example: >UNITY GAIN: CD OFF If commanded to set a particular input for unity then returns current input's unity status, for example: >UNITY GAIN: AUX4
>DISABLE [input]	For disabling unused inputs.	Lists all disabled inputs, for example: >DISABLED: CD
>ENABLE [input]	For re-enabling previously disabled inputs.	Lists all enabled inputs: >ENABLED: CD,AUX1,PHAUX2,AUX3,TUN,AUX4,AUX5,TAPE

		X4,AUX5,TAPE
>COUNTDN {ON OFF}	For toggling between muting and unmuting the power up countdown	Returns current countdown status.
>DSPLYOFF [n]	For automatically turning off the display after last command after programmed number of seconds 0 – 99, with 00 for always on.	Returns current time, in seconds, that display will shut off after last command, for example: >DSPLYOFF 00
>LOCKOUT [ON OFF]	For toggling between front panel locked and unlocked.	>LOCKOUT OFF for unlocked front panel >LOCKOUT ON for locked front panel
>VTL	Returns factory contact info	Contact VTL: Email: mail@vtl.com Tel. 909-627-5944 Fax. 909-627-6988
>VERSION	Returns the version number of the software.	Installed version of the software: >Version 072109

Powering the system off

You may keep your VTL preamplifier and your source components on permanently if you prefer to keep them warm. If you prefer to keep all your equipment off when not in use then it is best to follow the correct turn off sequence to avoid power off thumps through the system. (If the power fails or if you accidentally turn off the preamp before turning the power amplifiers off, the preamplifier will power down in a muted state and no damage will be done to your system.)

1. When you're done listening to your system always turn your power amplifier(s) off first, if not using the trigger function on the TL5.5.

2. Allow a short time (15 - 20 seconds) for the amplifier(s) to power down before you turn the preamplifier off. If the trigger function is being used, powering the preamplifier off will automatically turn off the power amplifier(s).
3. Turn the source components off, if you prefer to keep these off when not in use.

Care and Maintenance of your VTL preamplifier

Break In Period

Your VTL TL5.5 SERIES II preamplifier is a pure tube product designed to give you the continued optimum performance over an extremely long time period. Initially the tubes and circuits will require a burn-in period to reach maximum performance. During the first 100 hours of usage the preamplifier will undergo several improvements in sound. To break in the TL5.5 SERIES II you can leave it on with a music source connected to it and playing with the volume control turned to the 45 level. It is not necessary to have the power amplifier on during this break in period, as the preamplifier will still pass the signal.

Tube Life

Your VTL preamplifier has been designed to ensure long tube life. Tube replacement need not be considered until after approximately 2000 hours of use (roughly 2 to 3 years depending on your listening requirements.) As the tubes age beyond their peak performance there will be a general softening of the sound.

We recommend a complete replacement of the tubes in your preamplifier at that time, which will restore it to a “like new” sound quality. The tubes used in your TL5.5 Signature Preamplifier are specially matched and tested for this preamplifier. Please contact your VTL dealer or VTL factory service department to order the matched tubes for the preamplifier.

Note: use only tube types and tube brands that are recommended by VTL. VTL specified replacement tubes are available from your authorized VTL dealer or the VTL factory service department. Any damage incurred to units which use non-VTL approved tubes will not be covered under the warranty.

Changing Tubes

Do not attempt to change tubes yourself. Contact your authorized VTL dealer or the VTL factory service department and have the service performed by a trained technician. You will need to take the unit and this procedure to your dealer for them to perform this procedure properly.

Notes to the Service technician:

Re-tubing the VTL TL5.5 requires removal of the cover, which can expose potentially lethal voltages. Be sure to only touch the tubes themselves, and do not allow any part of your body or hanging jewelry to come into contact with any part of the circuit inside the unit.

Before working on the inside of either of the preamplifier chassis it is strongly recommended that the power supplies be properly discharged, as they can hold a charge for a long time after power down, and can cause damage to the circuit if discharged improperly.



When you look down from the top, you will see a printed circuit board mounted inside the preamplifier. **WARNING: DO NOT TOUCH ANYTHING INSIDE THE PREAMPLIFIER WITH YOUR FINGERS OR WITH ANY METALLIC OBJECT, UNTIL AFTER THE UNIT HAS BEEN SAFELY DISCHARGED.**



VTL preamplifiers can store energy in the power supplies long after they have been turned off, and incorrectly discharging the unit can damage the circuits, which will NOT be covered under the warranty. Be sure to understand these constraints before going any further. If at this stage you feel that you would rather not attempt this procedure yourself you should send the unit to VTL to have the work done.

Locate the tubes on the line stage PC board, which are plugged into sockets on the PC board located right next to the power supply. There are a total of six tubes, two 12AU7s and four 12AT7s. The following figure indicates the location of the tube type with respect to the sockets, looking from above and in front of the chassis.

If your TL5.5 II preamplifier is equipped with the optional internal phono stage, which is a separate PC board located to the left of the line stage board, there are an additional 6 tubes on the phono board. These tubes are 2 x 12AU7s, 2 x 12AT7s and 2 x 12AX7s.

1. Diagnose the tubes: If you are not undergoing a complete re-tube for the entire TL5.5, then you must first decide how many tubes and which tubes should be changed. Checking the tubes to determine whether they are within the acceptable range is strongly recommended – contact the factory for measurement points and ideal operating ranges.
2. Power off the TL5.5: To change tubes in this TL5.5 you should first power the unit down, unplug the unit from the wall outlet and disconnect the TL5.5 from the rest of the system. Let the TL5.5 stay powered off for at least 15 minutes before working with it. Make sure the tubes are cool before you touch them.



Using a Philips #2 point screwdriver for the top screws and a hex driver for the side panels, remove the protective cover from the chassis by loosening the screws from the sides and top of the TL5.5. Carefully remove the sides, cover and the screws and store them in a safe place.

3. Removing Tubes: Locate the tube you need to remove and hold onto the upper portion of the tube towards its tip. Being careful not to bend the

tube pins, gently and in small amounts rotate and rock the tube with your fingers to loosen it from its socket until its pins are completely disengaged from the socket. Take the tube out of the unit.

1. Plugging in a new tube: Hold onto the upper portion of the tube towards its tip. Lower the tube onto the socket, making sure that the pins from the tube match the holes in the socket. There are either two pins on the tube which are spaced at a wider distance from each other than the rest of the pins. Make sure that these locators go into the side of the socket that matches. Press the tube firmly into its socket, using a gentle force and a slight “rocking” motion. When the tube is properly and completely inserted into the socket it should be firmly seated and does not give in to any movement at all when you try to rock it gently. If the socket appears loose and not making contact with any or all of the tube pins, the socket should be re-tensioned.

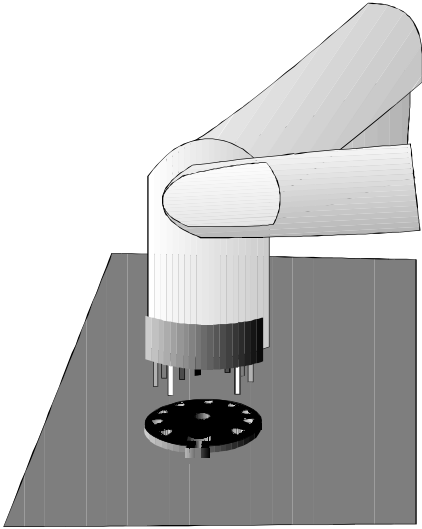

2. Replacing the protective cover: Lower the TL5.5's cover chassis slowly back onto the opened TL5.5 box, making sure that the cover is put on in the correct front and back position. Locate the screws that were removed from the cover and put them back in the correct holes. Replace the sides and tighten all screws to make sure that the cover is securely fastened to the unit.
3. Note that the slots on the top cover should match the slots on the transformer box inside the TL5.5. You should be able to see the parts inside the transformer box through the TL5.5's top cover when it is properly installed. If the parts are not visible through the slots, turn the cover around and install it in the other direction. See photo below for a properly installed top cover.

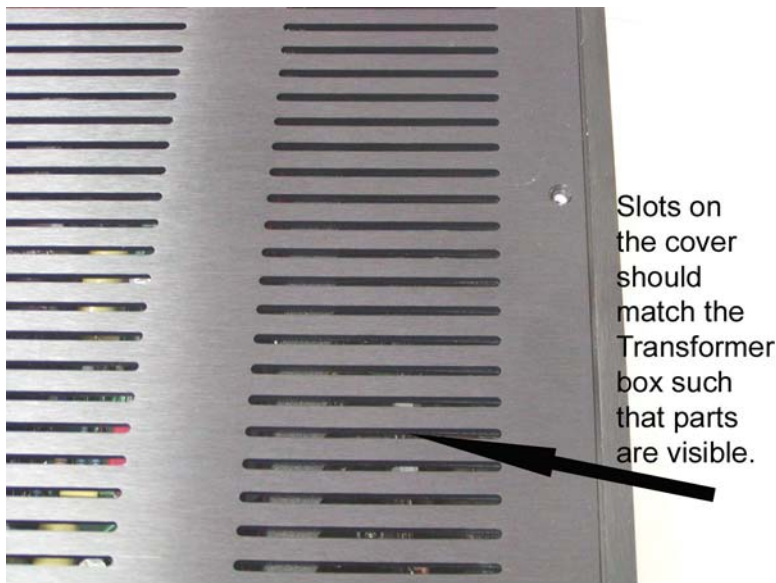

Preamp Top cover correct direction with parts showing.

Changing the Main Fuses

The Main fuse is housed in a fuse holder located on the back panel of the TL5.5, and is rated at 2A Slo Blo (100/120Volt AC) or 1A Slo Blo (220/240 Volt AC) ceramic.

The only fuse that is user serviceable is the Main AC fuse. To change the AC fuse first ensure the unit is powered off, and disconnect the AC power cord from the unit. Move the TL5.5 so that you can work with the panel in the back of the chassis.

The type of fitting used for the fuses is called a bayonet fit, which describes the action needed to remove the fuse cap. Locate the Main fuse holder, and loosen it by inserting a flat head screwdriver into the slot and turning the screw head approximately one quarter of a turn in a counter-clockwise direction while pressing inwards. The fuse cap should spring out from its housing with the fuse held inside the cap. Take the fuse out and replace it with a new one, and insert the fuse cap back into the holder, pushing it downward while turning it in the clockwise direction to lock it in place. Use the same procedure to replace the output stage protection fuses.



WARNING: For continued protection against fire hazard only replace the fuse with the same type and rating as was originally specified for the TL5.5. If you have problems locating the correct fuse contact your VTL dealer or the VTL factory service department.

Internal View of TL5.5 II Line Stage

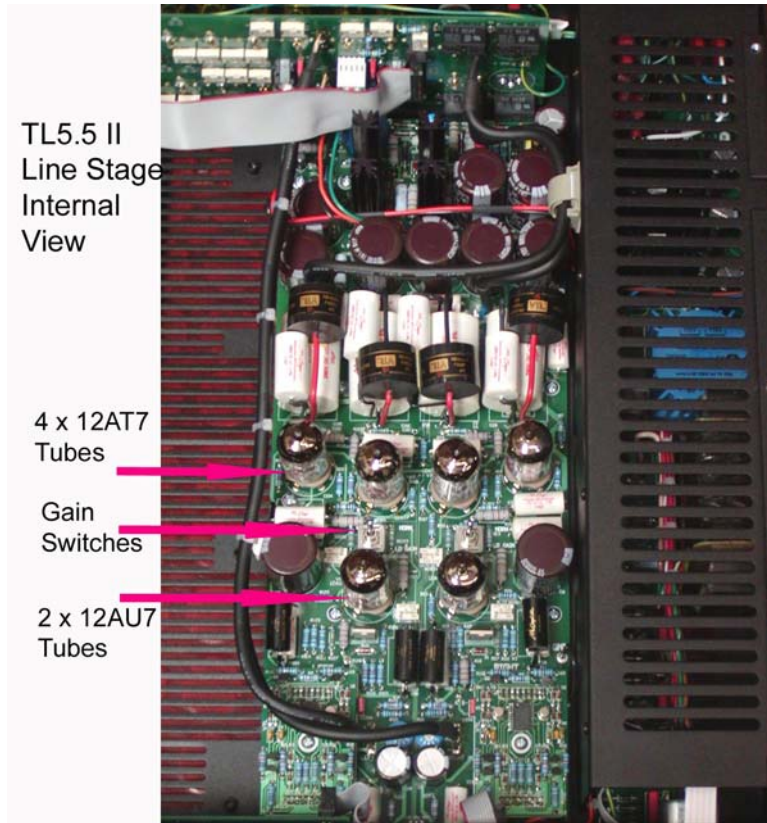

Internal View of TL5.5 II Line and Phono Stage

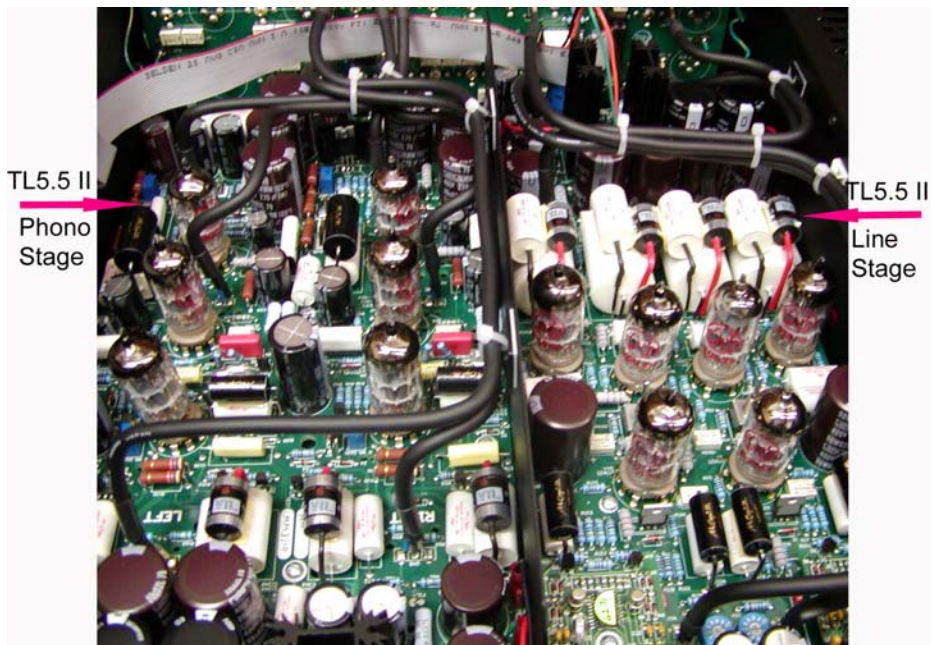

Internal View of TL5.5 II Phono Stage

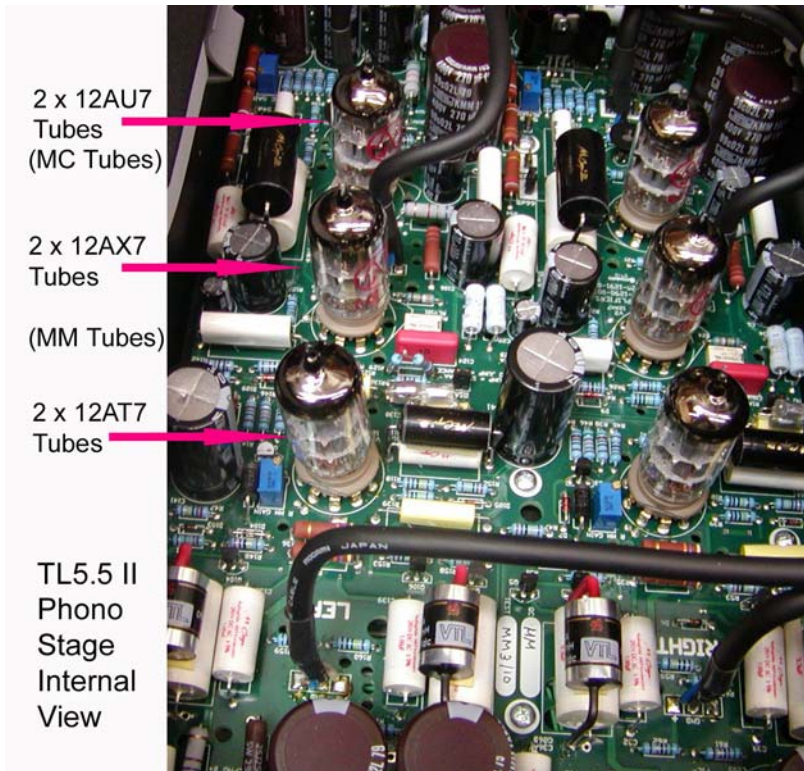

WARNING: Before powering on the TL5.5 after a fuse change it is extremely important to find the problem that caused the fuse to blow in the first place. Consult your dealer or the VTL factory for service.

Cleaning

Your VTL preamplifier should be dusted occasionally with a damp non-abrasive cloth. Do not use any solvents for cleaning the front panel, as this can damage the lettering and the finish. It is recommended that you use a contact cleaner such as Pro-Gold on the input and output connectors regularly to ensure optimum sound and proper signal conducting capability.

Troubleshooting

1. When I power on the preamplifier from the rear rocker switch, nothing happens. What should I do?

Check to make sure that the power cord is properly connected to the preamplifier and the AC outlet. If there is no problem with the power source,

check the fuse unit in the back panel of the preamplifier. If the fuse is blown, change the fuse, and turn the power on the preamplifier again. If the problem still persists, contact your authorized VTL dealer immediately.

2. When I play my CD the volume level at 01 seems to be too loud. What is the problem and what can be done about it?

Some CD players have a high output level, and require padding down. Either have the manufacturer of the player/DAC adjust the output to a lower level, or take your preamplifier to your dealer and ask them to set the internal gain switch of the TL5.5 to low gain. This will attenuate the input by approximately 12dB.

3. Using the remote control from another stereo component in my system affects the control of my VTL preamplifier. Why is this happening and what should I do?

Your VTL preamplifier is equipped with a remote control receiver unit that decodes signals coming from a proprietary micro controller code set that is based on the Phillips RC5 code set. If you own another stereo component that comes with a remote control unit using the same micro controller code set, the VTL preamplifier could pick up signals transmitted from this component as well. If your other remote unit also adopts the same standard, then there is a chance that the signals from both remotes may be interpreted as the same. If the functions with the same command are different for both units then one or other of the remote controls will have to be re-programmed. Contact your VTL Dealer or the Factory for a solution to this problem. *Note that in either case there is no damage being done to your VTL preamplifier while it is being used in these states, and you can continue to safely use the preamplifier until a solution is reached.*

Please contact the VTL factory service department to report this problem, as we would like to be made aware of which models of stereo equipment could cause this problem.

4. I am getting a noise and hum coming from my system when I turn the amplifiers on. What can I do to eliminate the noise?

It is recommended that you connect as many components as possible to a good clean AC ground in your system, and for quietest operation it is recommended that all components be plugged into the same ground potential (or same AC outlet, if this is not possible.) If however there are too many paths to ground then a ground loop hum can result and you should either contact your dealer or the VTL factory to try to resolve this problem.

5. I am getting a noise and hum coming from my video source. What can I do to eliminate the noise?

The noise may be coming in from your video cable system. First disconnect the VCR from the system to see if this will solve the problem. If it does then you will need to try to lift the ground from the cable TV wire by means of a cable ground lifting transformer available from most electronics stores. If the problem still

persists contact your VTL authorized dealer or the VTL factory service department.

6. I am getting a ringing noise from the preamplifier when I touch or bump it. What should I do?

One or more of the tubes in the preamplifier may be microphonic and the source of the problem. Follow the procedures listed in this manual to remove the tubes and change them for new ones.

7. I am getting no sound from one (or both) channel(s), but everything appears to be powered up properly. I have isolated the problem to the preamplifier, and I checked the mute and input selection on the preamp, and the tubes are glowing, but still I get no sound. What is the problem?

The unit should be taken to a dealer to have the fuses checked and replaced. If the correct fuses are in place there is most likely no damage to the unit, as the fuses are designed to open before damage occurs, so most likely the fuse replacement will fix the problem.

8. The fuses have been checked and they are fine, but there is still no sound. Now what is the problem?

In this case the dealer's service technician should contact the factory.

9. My remote control hand held unit for the preamplifier is not working. What should I do?

Look at the back of the remote control unit. Loosen the four screws with a Philips screwdriver, and open the back cover. Locate the two batteries inside the remote unit, and take the old batteries out and replace them with new AAA batteries. Put the back cover on and tighten the four screws, and test the remote unit to see if it is working properly.

If the remote control unit is still not functioning properly, contact your VTL authorized dealer or the VTL factory service department.

TL-5.5II Specifications

Vacuum Tube Complement	2 x 12AU7, 4 x 12AT7 (line stage)
Inputs	2 pair balanced/XLR or RCA single-ended 6 pairs single-ended/RCA
Outputs	1 pair balanced out 1 pair single-ended RCA out 1 pair single-ended RCA buffered Record Out
Remote Control Functions	Power Source Select Volume up/down Mute, Fade Balance Control, Phase Reverse
Gain	Normal Gain --11 dB single ended, 17dB balanced Switchable to Low Gain – 6 dB SE, 11 dB balanced
Output Impedance	150 Ohms (Max 400 ohms at 10Hz)
Input Impedance	35K Ohms
Frequency response + 0 - 1 dB	1 Hz - 200KHz +0 –1dB
Maximum Output Voltage < 1% THD	30 Volts 10Hz – 200kHz, 1.75V into 600 ohms at 1%THD
Channel Separation	> 100 dB @ 1KHz (>80 dB @ 20kHz)
Power Consumption	60 Watts (Line Stage) 130 Watts (with Phono stage)
Weight and Dimensions	40 lbs (18.12 Kg) Fully packed in one box Unpacked weight: 30 lbs (13.6 Kg) Unit Dimensions: 17.5 x 17.5x 4.75 in (44.45 x 43.18 x 12.06 cm)

TL5.5 II Phono Stage

	MM	MC
Tube Complement	2x12AX7, 2x12AT7	2x12AT7, 2x12AX7, 2x12AU7
Load	47K ohm	Selectable 100 ohm, 220 ohm, 470 ohm, 1K ohm, 47K ohm
Gain	40 dB	Selectable 54dB, 60dB, 66dB

Warranty

Warranty registration for VTL products is valid in the USA only. International VTL customers should consult the local VTL importer regarding product registration and warranty procedures.

VTL amplifiers and preamplifiers are covered by a limited warranty against defects in materials and workmanship for a period of 90 days from date of purchase by the original purchaser only, solely when purchased from an authorized VTL dealer. The warranty period begins on date of first sale to the end user, or one year after shipment from the VTL factory, whichever is the earlier. A further optional limited non-transferable five-year warranty is available to the original purchaser only upon proper registration of ownership within 30 days of date of first purchase.

In order to ensure the highest level of customer satisfaction, "new" VTL products may only be purchased over-the-counter or delivered and installed by an Authorized VTL Dealer. VTL products that are purchased over the Internet, by phone or mail order are presumed to be "used" and do not qualify for any VTL Warranty.

Proper registration is made by filling out and returning to the factory the original warranty card packed with the unit, along with a copy of the original sales receipt as proof of the original date of purchase, within 30 days of purchase.

The warranty is provided by the dealer where the unit was purchased, and by VTL Amplifiers Inc. Under the terms of the warranty defective parts will be repaired or replaced without charge, excepting the cost of tubes. A six-month warranty on tubes is available with the correct recording of the serial number of the VTL preamplifier on the warranty registration card and mailing it with the purchase receipt to VTL.

If a VTL product fails to perform properly under the above warranty then the purchaser's sole remedy shall be to return the product to the authorized VTL dealer or to VTL Amplifiers Inc, where the defect will be repaired without charge for parts and labor. The product will then be returned via prepaid, insured freight, method and carrier to be determined solely by VTL Amplifiers Inc. All returns to the factory must be in the original packing and accompanied by a Return Authorization, (new packing will be supplied for a nominal charge if needed), accompanied by a written description of the defect. This must be shipped to VTL Amplifiers Inc via insured freight at the customer's own expense. Charges for unauthorized service and transportation costs are not reimbursable under this warranty, and all warranties, express or implied, become null and void where the product has been damaged by misuse, accident, neglect, modification, tampering or unauthorized alteration by anyone other than VTL Amplifiers Inc. VTL does not warrant, in any way, products that are purchased from anyone who is not an Authorized Dealer or that have had their serial number altered or defaced.

This warranty applies only to units used in residential non-commercial use. The warrantor assumes no liability for property damage or any other incidental or consequential damage whatsoever which may result from failure of this product. Any and all warranties of merchantability and fitness implied by law are limited to the duration of the expressed warranty. All warranties apply only to VTL products purchased and used in the USA, and are only applicable within the USA. Products purchased outside the USA may not be registered for warranty with the factory in the USA, but may only be registered with the VTL distributor in the country of purchase. In the case of returns from outside the USA, the owner of the product returned is responsible for all shipping charges, and VTL will accept no shipping or customs duty charges for goods returned to the USA, nor any shipping or customs duty charges for the return of the product to the owner.

Some states do not allow limitations on how long an implied warranty lasts, so the above limitations may not apply to you. Some states do not allow the exclusion or limitation of incidental or consequential damages, so the above exclusion may not apply to you. This warranty gives you specific legal rights and you may also have other rights that vary from state to state.

Warranty Registration

Warranty registration for VTL products is valid in the USA only. International VTL customers should consult their local VTL dealer regarding product registration and warranty procedures.

To obtain valid US warranty service, please fill out the enclosed VTL Warranty Registration card and mail it to the following address with a **copy of your original bill of sale** within the first thirty days of purchase:

VTL Warranty Registration
4774 Murrieta Street, Suite 10
Chino, CA 91710
USA

To help you keep a record of the serial number and purchase information, please enter the following information into this manual.

Product Model Number: _____

Serial Number: _____

Purchase Date: _____

Authorized Dealer: _____

Service Notes

Date	Service	Initials
_____	_____	_____
_____	_____	_____
_____	_____	_____
_____	_____	_____
_____	_____	_____
_____	_____	_____