

LINA Network DAC

User Guide

Your guide to LINA

This User Guide is designed to help you experience the full potential of your dCS LINA Network DAC.

Inside, you'll find advice on how to set up, install, use and care for your system. We ask that you read it carefully before getting started. If you require further information or support, you can contact us at dcsaudio.com/contact.

We hope you enjoy listening, and are delighted to welcome you to the dCS community.

Document information

Published on: 14/03/2023

Document ID: DCS321671 - Rev1.02

Copyright

Copyright © 2023 Data Conversion Systems Ltd. All Rights Reserved.

Information contained in this manual is subject to change without notice, and whilst it is checked for accuracy, no liabilities can be accepted for errors.

dCS®, dCS Expanse®, and Ring DAC® are registered trademarks of Data Conversion Systems Ltd.

dCS is Data Conversion Systems Ltd. Company registered in England No. 2072115.

This product incorporates the following dCS proprietary technology: Ring DAC

Other product and company names may be trademarks or registered trademarks of other companies, and are the property of their owners. They are used only for explanation, without intent to infringe.

Intended purpose

This document advises users how to set up, use and configure the product.

Conventions in this document

This document uses the following safety notices and tips:



WARNING

Indicates a hazardous situation which, if not avoided, could result in death or serious injury.



CAUTION

Indicates a hazardous situation which, if not avoided, could result in moderate injury, damage the product, or lead to loss of data.

NOTICE

Indicates an important situation which, if not avoided, may seriously impair operations.



Additional information relating to the current section.

Contents

Safety	6
Getting started	8
What's in the box	8
Where to place the LINA Network DAC	8
Recommended cables and connectors	8
Overview	10
Front	10
Rear	12
Setting up	16
Connecting the power supply	16
Switching the unit on and off	16
Connecting the LINA range	17
Connecting audio source equipment	19
Connecting integrated amplifiers and preamplifiers	21
Connecting to your network	21
Connecting a computer	22
Clocking	23
Using Power Link	25
dCS Mosaic	26
Using the LINA Network DAC	27
Changing the source input	27
Playing music with Apple AirPlay	27
Playing music with Spotify Connect	28
Playing music from streaming services	28
About MQA files	28
Using Room	29
Playing music from a USB storage device	29
Settings	31
Navigating the menu	31
Menu overview	32
Changing the shortcut buttons	33
Changing the crossfeed setting	33
Changing the PCM filter	34
Changing the DSD filter	34
Changing the upsampling mode	34
Changing the absolute phase of analogue outputs	35
Unlocking and locking volume control	35
Setting the clocking sync mode	36

Enabling and disabling Dual AES	36
Setting the USB audio class	37
Enabling and disabling the buffer	37
Changing the line output level	38
Turning off the display	38
Changing the display brightness	38
Resetting to factory conditions	39
Testing for swapped channels	39
Conditioning the unit	40
Viewing information about the unit	40
Updating the software	40
Maintenance	41
Replacing a blown mains fuse	41
Cleaning the unit	42
Specifications	43
Support	45
Limited warranty	46
General information	46
Warranty exclusions	46
Obtaining service	47
Operating conditions	47
Compliance	48
Product label	48
FCC compliance statement	49
EU Declaration of Conformity	49
Korea Class B compliance statement	50
Made for iPhone® and iPad®	50
Works with Apple AirPlay	50

Safety

To prevent personal injury or damage to the unit, read the following safety messages before use.



CAUTION

Read and comply with all safety messages and instructions in this document.

- Follow the cleaning instructions in this document.
- Only install the unit according to the instructions in this document.
- Do not spill liquid on the unit or allow it to get wet.
- Do not install the unit near heat sources.
- Use only the attachments and accessories specified by dCS.



CAUTION

To prevent the risk of electric shock and ensure the best audio performance, connect the unit to mains earth (ground) using the correct power cable.

- A grounding type plug has two blades and a grounding prong, which is provided for safety. If the provided plug does not fit into your outlet, contact a qualified electrician.
- Do not use the power cable if it is damaged.
- If this unit is not being used for a long period of time, disconnect the unit from the power supply.
- During lightning storms, disconnect the unit from the power supply to prevent power surges.



CAUTION

The safety covers on the unit protect you from electric shock.

- Do not remove the safety covers from the unit.
- If you do remove the safety covers from the unit, it invalidates the warranty.



NOTICE

If the unit is damaged, do not use it and contact a qualified service engineer. Possible causes of damage to the unit include the following:

- Liquid is spilled on the unit.
- A heavy object falls on the unit.
- The unit is exposed to rain or moisture.
- The unit is dropped.

NOTICE

Damage caused to the unit by misuse of a mains regenerator or by a malfunctioning mains regenerator is not covered by the warranty.

- We do not recommend the use of mains regenerators.
- If you want to use a mains regenerator with variable voltage and frequency, set the voltage to match your local voltage. Set the frequency to either 50Hz or 60Hz.
- Do not change the output voltage of the mains generator while it is connected to the unit.

NOTICE

If the unit is cold and is moved into a warm room, condensation may form inside the unit. Condensation may interfere with the normal operation of the unit. If the unit has been kept somewhere cold, remove all packaging and leave it for 1-2 hours before using it to allow it to reach room temperature.

Getting started

What's in the box

The box contains the following items:

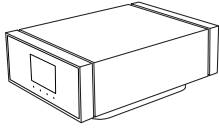

dCS LINA Network DAC

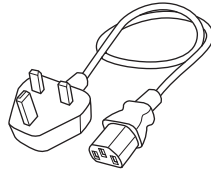

Power cable (2m)

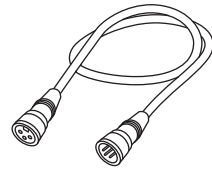

2x XLR cable (0.5m)

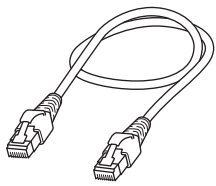

Ethernet cable (2m)

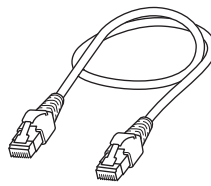

Power Link cable (0.5m)

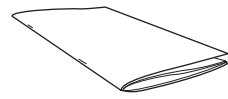

Getting Started Guide

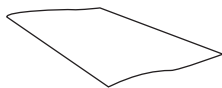

Spotify flyer

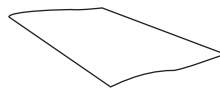

Welcome letter



Display cleaning cloth

If an item is missing from the box, contact your fulfilment centre.



We recommend that you keep the original packaging of the unit. If you need to order replacement packaging, contact your fulfilment centre.

Where to place the LINA Network DAC

To get the best sound quality:

- You can stack units vertically or place them next to each other.
- Ensure you can easily connect LINA Network DAC to other units of your system.
- If units are stacked vertically, place the bottom unit on a firm, vibration-free base.



To prevent overheating, we recommend that you leave some space around the units to allow for ventilation.

Recommended cables and connectors

We recommend the following cables and connectors for use with the unit. We supply "commercial" cables with the unit, but you can use cables and connectors of your preferred quality.

NOTICE

Heavy or inflexible power cables may damage the power socket on the unit.



Some “audiophile” cables have unusual grounding or screening arrangements, or they don't have the correct characteristic impedance. If you have difficulty using such cables but the problem disappears when you use standard cables, contact your cable manufacturer.

Digital inputs

Input	Recommended cable and connector
AES / EBU	110 Ω screened, twisted pair cables fitted with one male 3 way XLR connector and one female 3 way XLR connector.
Word Clock / SPDIF BNC	75 Ω coax cables fitted with BNC connectors.
SPDIF RCA	75 Ω coax cables fitted with RCA phono connectors.
Toslink	Toslink fibre-optic cables.
Network	RJ45 Ethernet cable.
USB	Standard screened USB 2.0 cable fitted with one type ‘A’ connector and one type ‘B’ connector. The internal screen must be connected at both ends.



The Word Clock sockets require a simple DC-coupled connection. If you use capacitor-coupled cables or cables with built-in networks, the interfaces may not work correctly.

Analogue outputs

Output	Recommended cable and connector
Balanced output	Screened, twisted pair cables fitted with one male 3 way XLR connector and one female 3 way XLR connector.
Unbalanced outputs	Coax cables fitted with RCA phono connectors.

Overview

Front

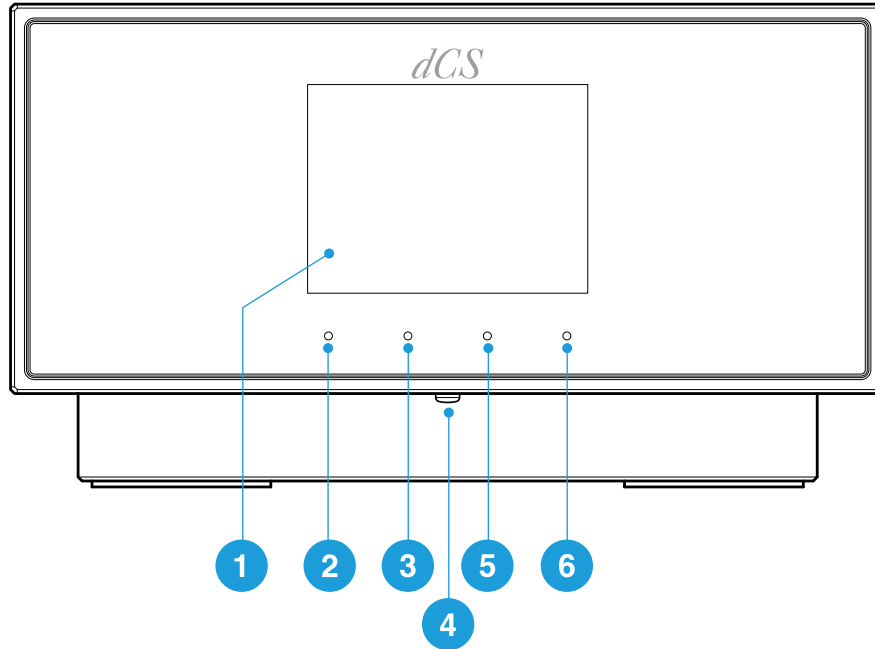

Item	Description
1	<p>Display</p> <p>Displays menus and information about the current input, for example, track name and artist.</p>
2	<p>Touch button</p> <p>Tap to select the option shown in the display above the button.</p> <ul style="list-style-type: none"> On the home screen, tap to use the assigned shortcut. In a menu, tap to move up a level or exit the menu.
3	<p>Touch button</p> <p>Tap to select the option shown in the display above the button.</p> <ul style="list-style-type: none"> On the home screen, tap to use the assigned shortcut. In a menu, tap to go to the previous page.
4	<p>Power button</p> <p>To switch on or enter sleep mode, press briefly.</p> <p>To switch off, press and hold until POWER OFF is displayed.</p>
5	<p>Touch button</p> <p>Tap to select the option shown in the display above the button.</p> <ul style="list-style-type: none"> On the home screen, tap to use the assigned shortcut. In a menu, tap to go to the next page.
6	<p>Touch button</p> <p>Tap to select the option shown in the display above the button.</p> <ul style="list-style-type: none"> On the home screen, tap to open the main menu. Touch and hold to change the function of the three shortcut buttons. In a menu, tap to select a menu item or change a setting.



You can assign your favourite settings to the three shortcut buttons on the home screen.

► For more information, see "Changing the shortcut buttons" on page 33.

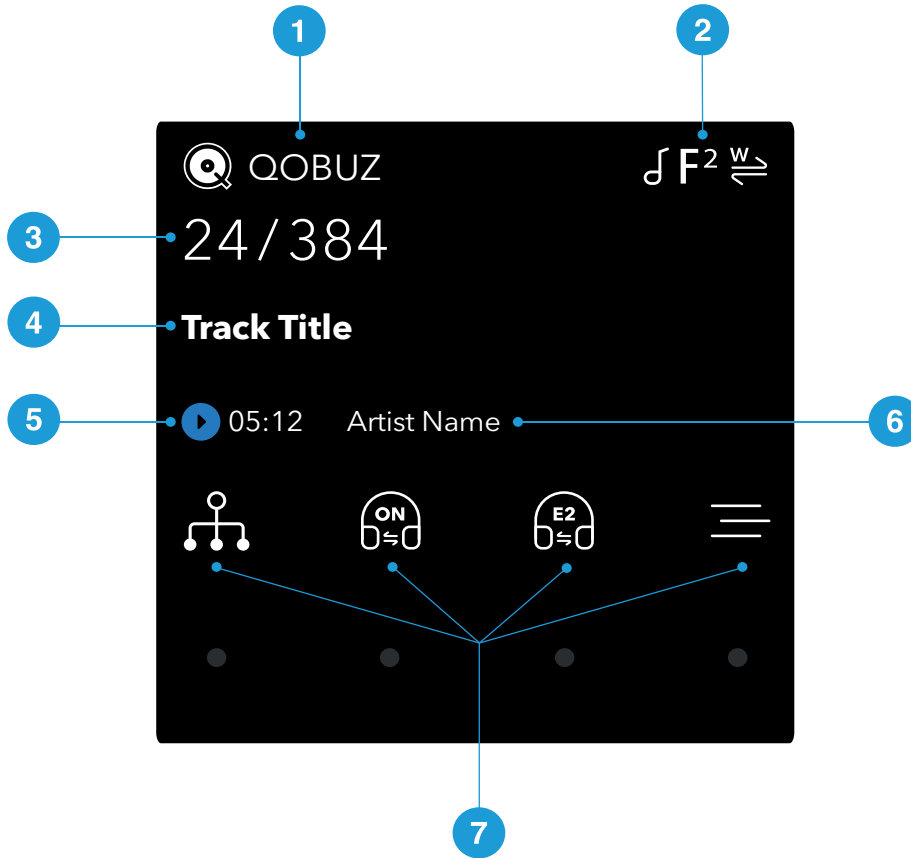

Description	
1	Input source
2	Status icons ► For more information, see "Status icons" on the next page.
3	Data rate (word length and sample rate for PCM, or DSD or DSDx2)
4	Track title*
5	Play/Pause icon and track elapsed time*
6	Artist name*
7	Menu, settings and shortcuts. To select the option, tap the relevant touch button. If an option is not available, the icon is greyed out.

*Displayed only when streaming from network or USB2

Status icons

Status icons are shown in the top-right of the home screen.

Icon	Description
	Filter setting when receiving PCM data
	Filter setting when receiving DSD data
	Clocking sync mode: Master
	Clocking sync mode: Audio
	Clocking sync mode: Word Clock (Auto, 1 or 2)
	Phase is normal
	Phase is inverted

Rear

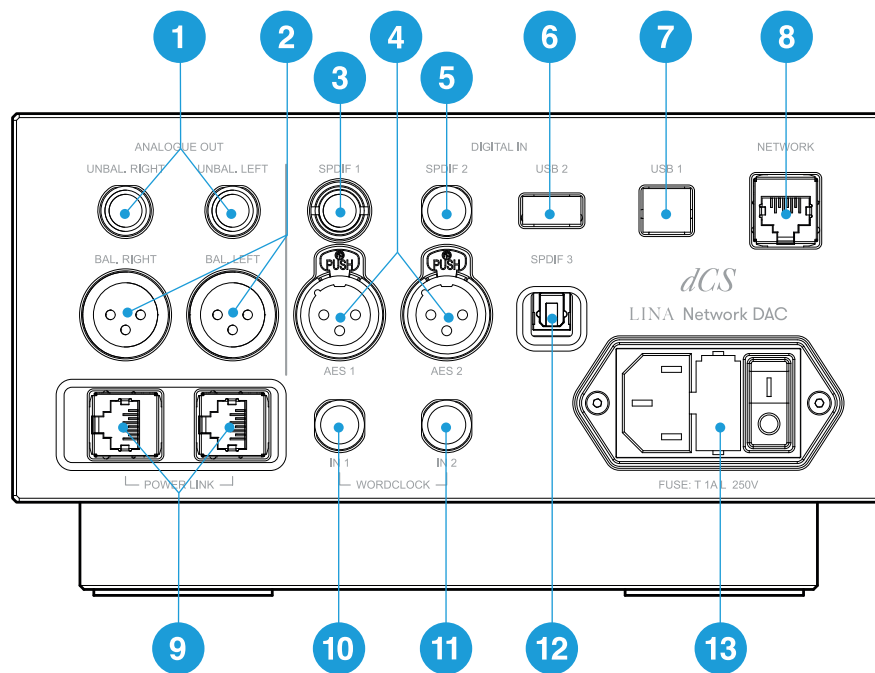

Item	Description
1 <i>UNBAL. LEFT</i> <i>UNBAL. RIGHT</i>	Stereo unbalanced RCA analogue outputs. Connects the unit to an integrated amplifier or preamplifier.
2 <i>BAL. LEFT</i> <i>BAL. RIGHT</i>	Stereo balanced XLR analogue outputs. Connects the unit to an integrated amplifier or preamplifier.
3 <i>SPDIF 1</i>	RCA digital input. Connects the unit to a digital audio source.
4 <i>AES 1</i> <i>AES 2</i>	XLR digital inputs. Connects the unit to a digital audio source, such as a CD transport or upsampler.

Item	Description
5	<i>SPDIF 2</i> BNC digital input. Connects the unit to a digital audio source, such as a CD transport or upsampler.
6	<i>USB 2</i> USB-A digital input. Connects the unit to a USB flash drive.
7	<i>USB 1</i> USB-B digital input. Connects the unit to a computer or sound server.
8	<i>NETWORK</i> RJ45 network input. Connects the unit to the local network or the Internet.
9	<i>POWER LINK</i> RJ45 input. Connects the unit to other LINA units to enable Power Link. ▶ For more information, see "Using Power Link" on page 25.
10	<i>WORDCLOCK IN 1</i> Word clock input 1. A 75 Ω BNC connector. Connects the unit to an external clock. Word clock is only used for synchronisation and does not carry digital audio data.
11	<i>WORDCLOCK IN 2</i> Word clock input 2. A 75 Ω BNC connector. Connects the unit to an external clock. Word clock is only used for synchronisation and does not carry digital audio data.
12	<i>SPDIF 3</i> Fibre optic Toslink input. Connects the unit to a digital audio source, such as a satellite receiver.
13	Power socket, fuse, and power switch Power is connected via a standard IEC320 connector, with a power switch and a fuse holder.

Analogue outputs

The balanced and unbalanced outputs on the unit are independent, which allows you to connect each output to a different amplifier.

Connect balanced outputs to true balanced inputs only. The outputs are electronically balanced and floating, which reduces hum or interference picked up by the cable. There are three connections:

- Pin 1: Screen / ground
- Pin 2: Signal +
- Pin 3: Signal -



The balanced outputs do not work correctly when they are connected to an unbalanced input.

Digital inputs

AES digital inputs

The *AES 1* and *AES 2* inputs individually accept PCM data at up to 192 kS/s, or DSD/64 in DoP format.

If Dual AES is enabled, you can use *AES1* and *AES2* together as a Dual AES pair. Dual AES supports the following data formats:

- PCM data (24/88.2 to 24/384)

- dCS-encrypted DSD data from Vivaldi, Rossini, Scarlatti, and Paganini Transports
 - DoP data (DSD/64 or DSD/128 over PCM)
- ▶ *For more information, see "Enabling and disabling Dual AES" on page 36.*
-  Dual AES works correctly only when the source generates Dual AES data. It is not the same as single AES data connected to both *AES1* and *AES2*.

SPDIF digital inputs

The *SPDIF 1* and *SPDIF 2* inputs accept PCM data at up to 192 kS/s, or DSD/64 in DoP format. *SPDIF 3* is a Toslink optical receiver that accepts PCM data at up to 96 kS/s.

USB sockets

The *USB 1* socket is a galvanically isolated 'B' type socket. It accepts audio data from a Windows™ PC, Apple Mac™, or sound server.

The *USB 1* socket can operate in two audio classes:

- Class 1, which accepts data at up to 96 kS/s. No additional drivers need to be installed on the connected computer.
- Class 2, which accepts data at up to 384 kS/s, or DSD/64 or DSD/128 in DoP format. A dCS USB Class 2 driver needs to be installed on computers running Windows™ versions before Windows™ 10 Creator's Update. No additional driver needs to be installed on Apple desktops and notebooks running macOS 10.6.3 or above.

 The *USB 1* socket has been tested with various PCM streaming programs on Windows™ 10, Windows™ 8.1, and macOS 10.11. However, the socket may not work with all devices, operating systems, or software.

▶ *For more information, see "Setting the USB audio class" on page 37.*

The *USB 2* socket is an 'A' type socket. It can stream PCM music files in formats at up to 24 bits / 384 kS/s or DSD/128. The connected USB device must be both of the following:

- A USB flash drive or low-powered USB hard drive, with the suggested maximum size of 32 GB
- In FAT32 or unencrypted NTFS format

Both USB sockets work in true asynchronous USB mode, which ensures the unit is not affected by clock jitter from connected devices.

Word clock inputs

The *WORDCLOCK IN 1* and *WORDCLOCK IN 2* sockets accept standard word clock at 44.1, 48, 88.2, 96, 176.4 or 192 kHz from a Master Clock or the source equipment.

The unit can only lock when the clock frequency is the same as the data rate, or an exact multiple of the data rate.

The sockets are used only for synchronisation and do not carry digital audio data.

Network socket

The *NETWORK* socket is an RJ45 connection that allows you to stream music from the local network or the Internet. The unit streams music files at up to 24 bits / 384 kS/s, or DSD/64, or DSD/128. The network interface runs in asynchronous mode and is galvanically isolated.

NOTICE

The metal contacts of the *NETWORK* socket can be damaged by accidentally inserting the wrong connector. When the socket is not in use, replace the dust cover.

Setting up

Connecting the power supply

Use the supplied power cable to connect your LINA Network DAC to the power supply.

1. At the rear of the unit, insert the power cable into the power socket.
2. Connect the plug to a power supply.

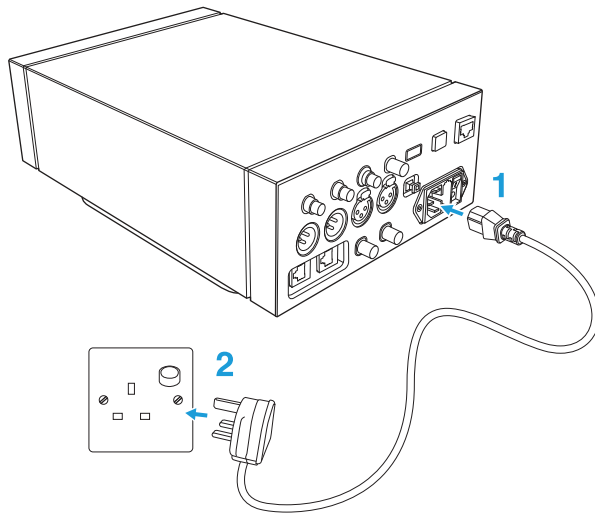

Switching the unit on and off

At the rear of the unit, there is a power rocker switch next to the power cable. There is also a power button on the front panel.

To switch on the unit:

1. On the rear of the unit, press the power rocker switch to the *I* position.

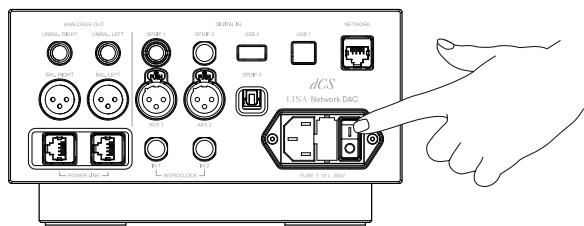

2. On the front of the unit, press the *Power* button.

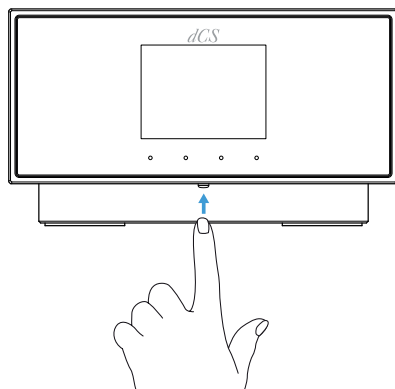

To switch off the unit:

- Press and hold the *Power* button until **POWER OFF** is displayed.

Using sleep mode

Sleep mode suspends the unit in its current state, but keeps it ready for quick use.

- To enter sleep mode, briefly press the *Power* button.
The display turns off.
- To exit sleep mode, press the *Power* button again.



To prevent screen burn-in of the display, switch the unit off or put it in sleep mode when not in use.

Connecting the LINA range

To connect the LINA Network DAC, LINA Master Clock and LINA Headphone Amplifier together:

1. Position the LINA range.
2. Connect the LINA Network DAC to the LINA Headphone Amplifier.
3. Connect the LINA Master Clock to the LINA Network DAC.

1. Positioning the LINA range

You can position the units in one of the following ways:

- Place the units side by side.
- Stack the units vertically in the following order:
 - LINA Headphone Amplifier at the bottom
 - LINA Master Clock in the middle
 - LINA Network DAC on top



To prevent overheating, we recommend that you leave some space around the units to allow for ventilation.

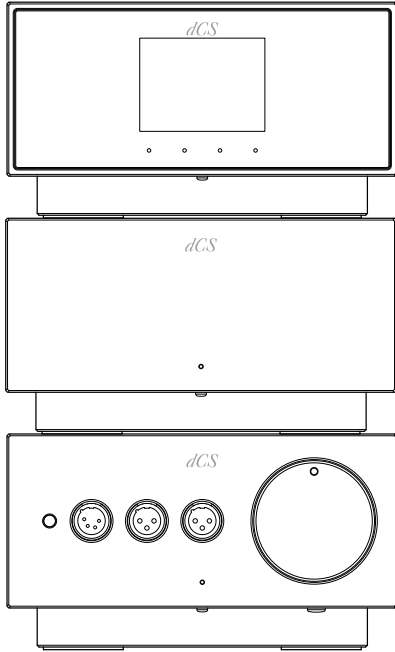

2. Connecting the LINA Network DAC to the LINA Headphone Amplifier

You can connect the LINA Network DAC to the LINA Headphone Amplifier using the balanced XLR sockets.

1. Using two balanced XLR cables, connect the *BAL. LEFT* and *BAL. RIGHT* outputs on the LINA Network DAC to the *BAL. LEFT* and *BAL. RIGHT* inputs on the LINA Headphone Amplifier.

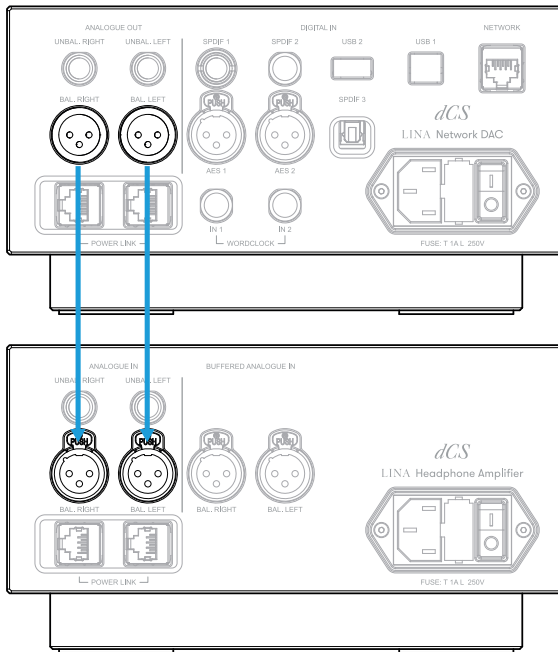

2. On the LINA Headphone Amplifier, choose the unbuffered XLR input. If the status indicator is not white, press the *Power / Input* button until it changes to white.

3. Connecting the LINA Master Clock to the LINA Network DAC

You can lock the network and USB inputs on the LINA Network DAC to the LINA Master Clock.

1. Switch on the LINA Network DAC and the LINA Master Clock.
2. On the LINA Network DAC, choose the network or USB input.
 - ▶ For more information, see "Changing the source input" on page 27.
3. Using two BNC cables, connect the *WORDCLOCK* output sockets on the LINA Master Clock to the *WORDCLOCK* input sockets on the LINA Network DAC.

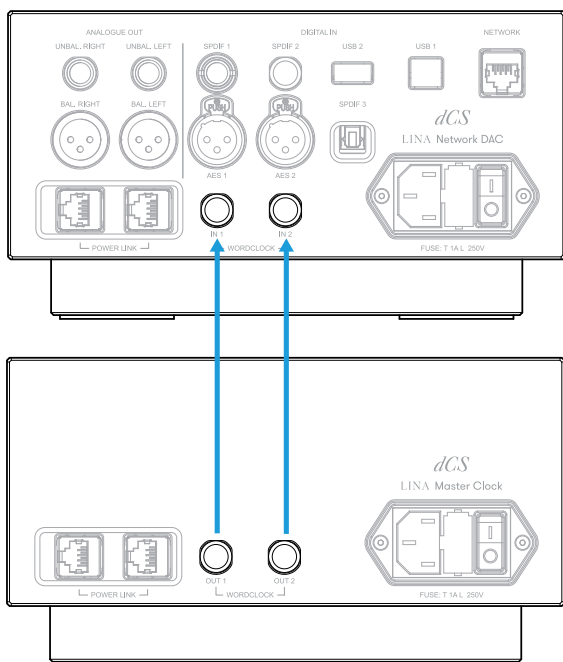

4. Set the clocking sync mode on the LINA Network DAC to Auto \rightleftarrows .
 - ▶ For more information, see "Setting the clocking sync mode" on page 36.
 The LINA Network DAC selects the appropriate clock input and locks to it.

 If you lock an AES or SPDIF input on the LINA Network DAC to the LINA Master Clock, the source equipment will not be locked to the Clock, resulting in periodic clicks, dropouts or distortion.

To use the LINA Network DAC in this way, use source equipment that has a word clock input and a Master Clock with extra outputs.

Connecting audio source equipment

You can use the input sockets on the rear of the LINA Network DAC to connect audio equipment to the unit, for example, CD transports, DVD players, or upsamplers.

There are two types of input sockets on the unit:

- AES (Audio Engineering Society)
- SPDIF (Sony/Philips Digital Interface)



If you lock an AES or SPDIF input on the LINA Network DAC to the LINA Master Clock, the source equipment will not be locked to the Clock, resulting in periodic clicks, dropouts or distortion.

To use the LINA Network DAC in this way, use source equipment that has a word clock input and a Master Clock with extra outputs.

Connecting a single AES or SPDIF input

Most digital audio source equipment is fitted with at least one digital output, which is usually an RCA phono connector. Satellite receivers usually have a Toslink optical output.

1. At the rear of the LINA Network DAC, connect a suitable cable to one of the following sockets:
 - AES 1
 - AES 2
 - SPDIF 1
 - SPDIF 2
 - SPDIF 3
2. Connect the other end of the cable to the source equipment.
3. Switch on the source equipment.
4. If possible, play music on the source equipment to generate an audio signal.
5. Change the source input on the unit.

► *For more information, see "Changing the source input" on page 27.*

After you have selected the input, the display shows the bit rate and format of the current music.

Connecting a Dual AES input

Some audio equipment, for example, upsamplers or sound servers, can output in Dual AES. Dual AES features lower jitter than single AES or SPDIF.



Some audio equipment has two single AES outputs that carry identical data. This is not the same as Dual AES, and will be in mono if you set Dual AES mode manually. To avoid this, we recommend using the Auto setting for Dual AES.

1. Using XLR cables, connect your LINA Network DAC to the source equipment. Ensure the cables are not swapped.
 - Connect the AES1 (or AES A) output on the source equipment to the AES 1 socket on the unit.
 - Connect the AES2 (or AES B) output on the source equipment to the AES 2 socket on the unit.
2. Switch on the source equipment.
3. If possible, play music on the source equipment to generate an audio signal.
4. Ensure that Dual AES is enabled on the unit.
 - *For more information, see "Enabling and disabling Dual AES" on page 36.*
5. Change the source input on the unit to **DUAL AES**.

- ▶ For more information, see "Changing the source input" on page 27.

After you have selected the input, the display shows the bit rate and format of the current music.

Connecting integrated amplifiers and preamplifiers

You can connect your LINA Network DAC to integrated amplifiers and preamplifiers. The unit has two types of analogue output connections: balanced and unbalanced. These outputs are independent, which allows you to connect each output to a different amplifier.

NOTICE

If you plan to directly connect your LINA Network DAC to a power amplifier, unlock the volume control and reduce the volume level before setting up LINA Network DAC with your system.

- ▶ For more information, see "Unlocking and locking volume control" on page 35.



Connecting the unit's balanced output to an unbalanced input using an XLR cable is not recommended, as it results in hissing noises, unstable levels, and a thin sound.

1. Switch on the amplifier and set it to a low volume.
2. Connect cables to the rear of the unit.
 - If you are using the balanced outputs, connect XLR cables to the *BAL. LEFT* and *BAL. RIGHT* sockets.
 - If you are using the unbalanced outputs, connect RCA phono cables to the *UNBAL. LEFT* and *UNBAL. RIGHT* sockets.
3. Connect the other end of the cables to the amplifier.
 -  The inputs on the amplifier may be labelled CD or AUX.
4. Select the chosen input on the amplifier and play some music.
 - ▶ For more information, see "Using the LINA Network DAC" on page 27.
5. While music is playing, slowly increase the amplifier volume to the desired level.

Connecting to your network

If you connect your LINA Network DAC to a network, you can stream content from local sources, such as a music server on your network, or from Internet services.

Before connecting the unit to your network, ensure you have the following items:

- A Wi-Fi network router with spare Ethernet sockets. To stream content from internet services, your router must be connected to the Internet.
- A mobile device with the Mosaic Control app installed.
 - ▶ For more information, see "dCS Mosaic" on page 26.
- Optional: A music server, such as a Network Attached Storage (NAS) server. The music server must be UPnP (Universal Plug and Play) compatible, and must be connected to the router via an Ethernet cable.

We fully test our products with the MinimServer UPnP server software. For more information about MinimServer, visit www.minimserver.com

💡 For more information about configuring your network, contact your local service centre or a local IT expert.

To connect your LINA Network DAC to your network:

1. At the rear of the unit, connect an Ethernet cable to the *NETWORK* socket.
2. Connect the other end of the Ethernet cable to your router.
3. On your mobile device, connect to the same network as your router.
4. On your mobile device, open the Mosaic Control app and connect to your LINA Network DAC.

💡 To stream from internet services, your router must be connected to the internet.

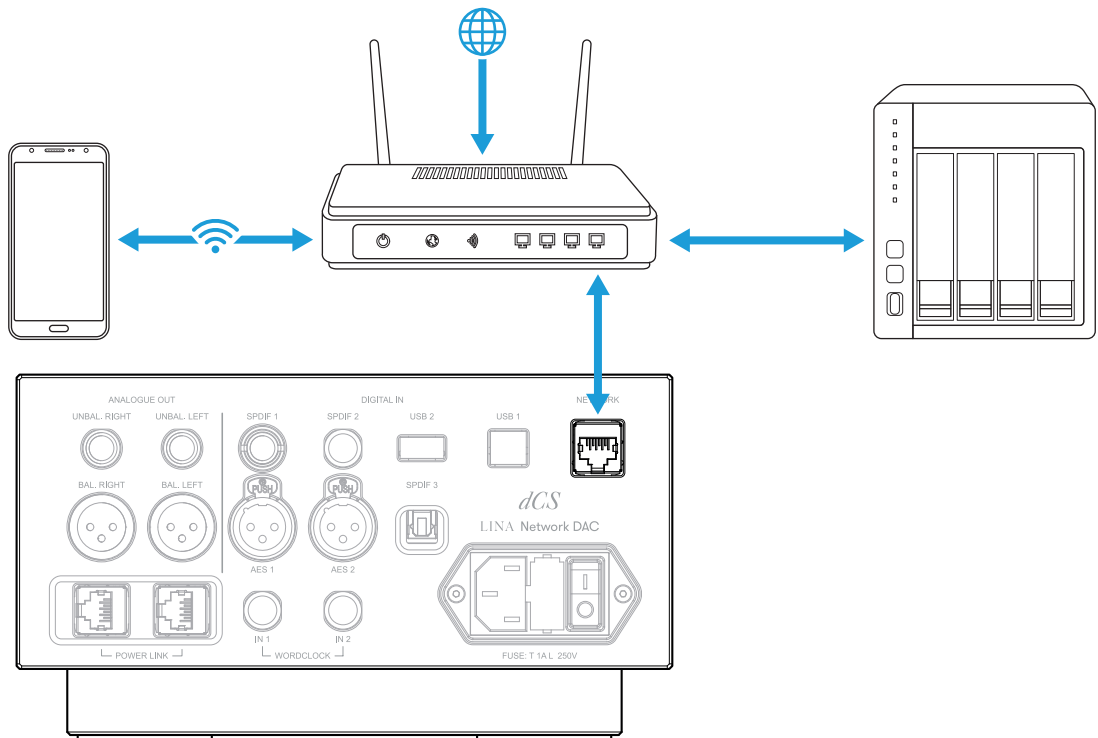

Connecting a computer

You can connect a computer to the *USB 1* socket on your LINA Network DAC. For best results, we recommend using a premium music streaming program instead of software included with the operating system.

The *USB 1* socket can operate in two audio classes:

- Class 1, which accepts data at up to 96 kS/s. No additional drivers need to be installed on the connected computer.
- Class 2, which accepts data at up to 384 kS/s, or DSD/64 or DSD/128 in DoP format. A dCS USB Class 2 driver needs to be installed on computers running Windows™ versions before Windows™ 10 Creator's Update. No additional driver needs to be installed on Apple desktops and notebooks running macOS 10.6.3 or above.

 The *USB 1* socket has been tested with various PCM streaming programs on Windows™ 10, Windows™ 8.1, and macOS 10.11. However, the socket may not work with all devices, operating systems, or software.

- ▶ For more information, see "Setting the USB audio class" on page 37.
 1. Using a USB cable, connect a computer to the *USB 1* socket on the rear of the unit.
 2. Change the source input on the unit to **USB / PC**.
 - ▶ For more information, see "Changing the source input" on page 27.
 3. In your streaming program, select the LINA Network DAC as the output device.

Selecting LINA Network DAC as the audio output device on your computer

To listen to music from your computer on the unit, you may need to change your preferred audio output device.

macOS™

1. Select **Finder**.
2. Select the **Go** tab.
3. Select **Utilities > Audio MIDI Setup**.
4. Use the right mouse button to select **dCS Lina Network DAC**.
5. Select **Use this device for sound output**.
6. To get the best sound quality, set the format to **384000.0Hz** and **2ch-24bit Integer**.
7. Close **Audio MIDI Setup**.

Windows™ 10 and Windows™ 8.1

1. Open the Control Panel and select **Sound**.
2. Select the **Playback** tab.
3. Use the right mouse button to select **dCS Lina Network DAC**.
4. Select **Set as Default Communication Device**.
5. To get the best sound quality:
 - a. Select **Properties**.
 - b. Select the **Advanced** tab.
 - c. Select **24 bit, 384000 Hz (Studio Quality)**.
 - d. In the **Exclusive Mode** options, select both options.
6. Close the **Sound** window.

Clocking

Clock jitter is variation in the digital audio clock frequency, which can cause a loss of fine detail when listening to music. The unit can run in different clocking sync modes, which can reduce jitter. To minimise jitter, connect the unit to the LINA Master Clock or a compatible Master Clock.

- ▶ For more information, see "Connecting the LINA range" on page 17.

Clocking sync mode	Inputs	Description
Master (M)	Network and USB	The unit uses its internal clock to control data delivery from the network, computer or flash drive.
Audio (A)	AES and SPDIF	The unit locks to the data stream from the source equipment.
Word Clock • Auto (W)	Network and USB	The unit locks to a Master Clock and controls data delivery from the network, computer or flash drive.
• 1 (W ¹) • 2 (W ²)	AES and SPDIF	The unit and the source equipment lock to a Master Clock. The source equipment's word clock input must be connected to a Master Clock output at the correct frequency.



The sync mode setting is stored separately for each input.

Using the unit in Master mode

When using the network or USB inputs, the unit automatically defaults to Master mode if a Master Clock is not connected. If you prefer, you can set these inputs to Master mode, ignoring any connection to the word clock inputs.

- ▶ For more information, see "Setting the clocking sync mode" on page 36.

Using the unit in Audio sync mode

When using the AES or SPDIF inputs, you can set the unit to lock to the data stream from the source audio equipment.

1. Switch on the unit.
2. Switch on the source audio equipment.
3. On the unit, choose the input you want to lock.
 - ▶ For more information, see "Changing the source input" on page 27.
4. Set the clocking sync mode on the unit to Audio.
 - ▶ For more information, see "Setting the clocking sync mode" on page 36.

Locking the unit to a Master Clock

To minimise jitter, you can lock the unit to a Master Clock. If the Master Clock has an available output, you can use it to also clock another audio source, such as a CD transport.

1. Switch on the unit and the Master Clock.
2. On the unit, choose the input you want to lock to the Master Clock.
 - ▶ For more information, see "Changing the source input" on page 27.
3. Using two BNC cables, connect the *WORDCLOCK* output sockets on the Master Clock to the *WORDCLOCK* input sockets on the unit.
4. If you are also locking another audio source to the Master Clock, switch it on and connect the Master Clock to the word clock input on the source equipment.

5. Set the clocking sync mode on the unit to Word Clock 1-2 Auto.
 - ▶ For more information, see "Setting the clocking sync mode" on page 36.
- The LINA Network DAC selects the appropriate clock input and locks to it.

Using Power Link

Power Link allows you to switch LINA units on and off at the same time, or put the LINA Network DAC and LINA Master Clock in and out of sleep mode at the same time.

To enable Power Link, use two RJ45 cables to connect the *POWER LINK* sockets on each unit.

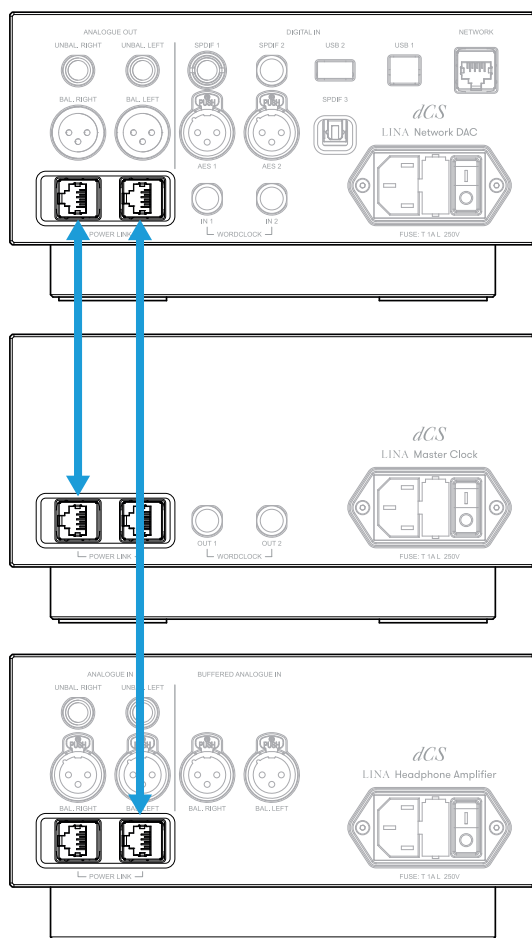

dCS Mosaic

dCS Mosaic is a bespoke collection of hardware and software modules that allow you to access your digital music. With dCS Mosaic, you can stream content from the following:

- Local streaming sources, such as a music server on your network or using Apple AirPlay
- Internet services, such as Spotify, TIDAL, Qobuz and Deezer
- Internet Radio
- Podcasts via Airable

The Mosaic Control app

Mosaic Control is an app for your iOS or Android mobile device. With the Mosaic Control app you have access to a vast library of music through a simple, yet powerful interface. You can use the app to:

- Browse media from various streaming services
- Manage settings and configuration options for your dCS products

To download the Mosaic Control app, visit the app store on your iOS or Android device and search for dCS Mosaic.





Help using the Mosaic Control app

To view the User Guide for the Mosaic Control app, visit <https://dcs.community/t/dcs-mosaic-user-guide/>









Using the LINA Network DAC



Changing the source input

You can cycle through the available source inputs using the menu.

1. Tap .
2. Tap .
3. Tap  to change the input.

Each time that you tap the button, it advances through the list of available inputs.

Icon	Input name
	NETWORK
	AES 1
	AES 2
	DUAL AES
	SPDIF 1
	SPDIF 2
	SPDIF 3
	USB 1

-  If a USB flash drive is connected to the USB 2 socket, the unit treats it as a network drive. Select the input using the Mosaic Control app.
-  If Dual AES is disabled, **DUAL AES** is not shown in the list of inputs.
 - ▶ For more information, see "Enabling and disabling Dual AES" on page 36.
-  Streaming a track from the network automatically selects the network input.

Playing music with Apple AirPlay

Use Apple AirPlay to wirelessly stream music from Apple devices. For more information, see www.apple.com/airplay.

1. Connect your Apple device to the same Wi-Fi network as your LINA Network DAC.
2. Swipe down from the top-right of the screen on your Apple device to access the Control Center.
3. Tap the AirPlay icon  and then select your LINA Network DAC.

When AirPlay is active, the unit's network input is automatically selected.



To play music stored on an Android device in a similar way, use a UPnP (Universal Plug and Play) app such as BubbleUPnP.

Playing music with Spotify Connect

You can use your phone, tablet or computer as a remote control for Spotify.



1. Connect the device that runs the Spotify app to the same Wi-Fi network as your LINA Network DAC.
2. Open the Spotify app and play a song.
3. At the bottom of the screen, select **Devices Available**.
4. From the list of devices, select your LINA Network DAC.

For more information on how to set up and use Spotify Connect, see www.spotify.com/connect.

The Spotify software is subject to third-party licenses: www.spotify.com/connect/third-party-licenses.

Playing music from streaming services

You can use the Mosaic Control app to play music from online streaming services, such as Spotify, TIDAL, Qobuz, and Deezer. You can also listen to Internet Radio, and podcasts via Airable.

► For more information, see "dCS Mosaic" on page 26.

About MQA files

MQA (Master Quality Authenticated) is an award-winning British technology that delivers the sound of the original master recording. The master MQA file is fully authenticated and is small enough to stream or download. Your LINA Network DAC features a full MQA decoder.



For more information about MQA technology, see www.mqa.co.uk



MQA files that are streamed bit-perfect using a network connection or from the *USB 2* socket are extracted and rendered to the original sample rate. The decoded sample rate is shown on the display.

MQA files extracted by another device to 24/88.2 or 24/96 and then presented bit-perfect to the *USB 1*, *AES 1*, *AES 2*, *SPDIF 1*, *SPDIF 2*, or *SPDIF 3* sockets are rendered to the original sample rate.

When listening to MQA files using a network connection, the Mosaic Control app displays the type of MQA stream.

Icon	Description
	Indicates that the unit is decoding and playing an MQA stream or file, and denotes provenance to ensure that the sound is identical to that of the source material.
	Indicates that the unit is playing an MQA Studio file, which has either been approved in the studio by the artist/producer or has been verified by the copyright owner.
	Indicates that the product is receiving an MQA stream or file. This delivers the final unfold of the MQA file and displays the original sample rate.

NOTICE

If the original data in an MQA file has changed, the unit cannot decode the file.

For files to be identified as containing MQA audio and sent to the MQA decoder for authentication, the metadata in the file must include the correct MQA tags. If the metadata of an MQA file has been changed, removed or was never present (for example if the files were ripped from an MQA-encoded CD), the files will not be recognised and decoded.

To fix the metadata of MQA files, use the MQA Tag Renaming application. The application reads the MQA markers in the bit stream and applies the appropriate metadata tags to the files. For more information on the MQA Tag Renaming application, see:

<https://www.mqa.co.uk/customer/tag435sdf43te>.

The MQA logo is a trademark of MQA Limited and is used under licence. MQA and the Sound Wave Device are registered trademarks of MQA Limited © 2016.

Using Roon

The LINA Network DAC is Roon Ready.



If you have a Roon account, install Roon Core on your NAS drive or on a networked computer. You can then use Roon remote to control playback on your unit.

For more information about Roon, see <https://roonlabs.com/>

Playing music from a USB storage device

You can play music stored on a USB storage device. The connected USB device must be both of the following:

- A USB flash drive or low-powered USB hard drive, with the suggested maximum size of 32 GB
- In FAT32 or unencrypted NTFS format

NOTICE

Do not try to play non-audio files on the unit. If the unit stops responding, restart the unit.

To play music from a USB storage device:

1. At the rear of the unit, connect the USB storage device to the *USB 2* socket.
2. Open the Mosaic Control app and access the USB storage device.
3. Choose a song to play on the LINA Network DAC.
 - ▶ *For more information, see "dCS Mosaic" on page 26.*

Settings

You can change settings in the menu on the unit, or using the Mosaic Control app.

► For more information, see "dCS Mosaic" on page 26.

To change settings for the unit using the Mosaic Control app, select ☰ from the left of the screen on your mobile device.

Navigating the menu



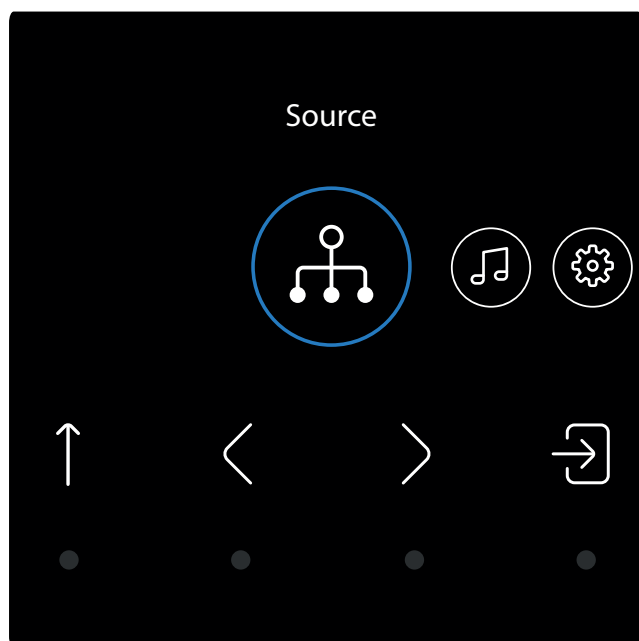















































To navigate the menu on the unit, tap the buttons below the display.



☰	Open the main menu	<	Move to the previous item
↑	Move up a level or exit the menu	>	Move to the next item
→	Enter or select		

Menu overview

The table below shows the menus and settings available on the unit.

Source 		NETWORK 	AES 1 	AES 2 	DUAL AES 		
		SPDIF 1 	SPDIF 2 	SPDIF 3 	USB 1 		
Processing 	Crossfeed 	Off 	Crossfeed 	Expanse 1 	Expanse 2 		
	Filter F1	Filter 1 F1	Filter 2 F2	Filter MQA M1			
	DSD Filter F1 <small>DSD</small>	DSD F1 F1 <small>DSD</small>	DSD F2 F2 <small>DSD</small>	DSD F3 F3 <small>DSD</small>	DSD F4 F4 <small>DSD</small>		
	Upsampling 	DSD 	DXD 				
	Phase 	In phase 	Inverted 				
Device Settings 	Volume Lock 	Locked 	Unlocked 				
	Sync Mode 	W Auto 	Audio 	Master 	W/C 1 	W/C 2 	
	Dual AES 	Off 	On 	Auto 			
	USB Class 	Class 2 	Class 1 				
	Buffer 	Off 	On 				
	Line Output 2V	0.2V .2V	0.6V .6V	2V 2V	6V 6V		
	Display 	On 	Off 				
	Brightness 	1 - 15 					
		Factory Reset 					
Test 	Channel Check 						
	Burn In 						
Information 							

Changing the shortcut buttons



From the home screen, three of the touch buttons act as shortcut buttons. Tap these buttons to quickly change your favourite settings. The default shortcut buttons do the following:

- Change the input source.
- Toggle crossfeed on or off.
- Change the crossfeed setting.

When you unlock the volume control feature, the default shortcut buttons do the following:

- Change the input source.
- Change the volume.
- Mute/Unmute (for AES, SPDIF, or USB 2 input sources) or Play/Pause (for NETWORK or USB 1 input sources).

To choose a different shortcut action:





1. Touch and hold .
Three white, square reset icons appear on the display.
2. Tap the button for the shortcut you want to change to choose a different action.
3. Tap  to save changes.

Changing the crossfeed setting

Crossfeed is the process of blending left and right channels of a stereo audio recording, to help make audio sound more natural when played through headphones. The crossfeed setting that is most suitable for you and the music you are listening to may vary, so we recommend testing the different settings.

dCS Expanse

Expanse is the new patent-pending crossfeed processing algorithm developed by dCS. It applies different processing filters to give two different responses: E1 and E2. With Expanse, there is a unique headphone listening experience for all listeners that stays true to the original recording.

1. Tap .
2. Tap  to select **Processing**.
3. Tap .
4. Tap  to change the crossfeed setting.



Crossfeed off. The two audio channels are presented to the headphones in the usual way.



Crossfeed on. Some of the signal from one channel is filtered and mixed with the other channel to better imitate listening to loudspeakers in a room.







Expanse filter 1.



Expanse filter 2.

Changing the PCM filter

You can use the filter settings to change how music sounds when listening to PCM data. Filters are a personal choice. A different filter setting is stored for each sample rate.





1. Tap .
2. Tap  to select **Processing**.
3. Tap .
4. Tap  to select **Filter**.
5. Tap  to change the PCM filter.





F1	Filter 1. The filter has the best rejection of unwanted Nyquist images with the sharpest roll-off, but poor transient response.
F2	Filter 2. The filter has a more relaxed image rejection and better transient response. Filter 2 is recommended for orchestral music.
M1	MQA filter. Automatically selected when an MQA file is playing.

Changing the DSD filter

The DSD filter is active when you are playing DSD files or upsampling PCM data to DSD.

 If you are playing a DSD file or upsampling to DSD, and the level of hiss at the output is high, your amplifier may not work well with wideband DSD signals. Try setting the DSD filter to Filter 2 or 3.



1. Tap .
2. Tap  to select **Processing**.
3. Tap .
4. Tap  to select **DSD Filter**.
5. Tap  to change the DSD filter.

F1 	Filter 1. The default setting, which gives the widest bandwidth and the highest level of out-of-band noise.
F2 	Filter 2. Reduces the out-of-band noise and bandwidth.
F3 	Filter 3. Reduces the out-of-band noise and bandwidth further.
F4 	Filter 4. Recommended for troubleshooting only. Sharply reduces the out-of-band noise and also limits the bandwidth to 25 kHz.

Changing the upsampling mode

You can select between two processing options when receiving PCM data. The best upsampling mode is a personal choice.

1. Tap .
2. Tap  to select **Processing**.







3. Tap .
4. Tap  to select **Upsampling**.
5. Tap  to change the upsampling mode.

 **DSD.** The unit adds a DSD upsampling step before the end of the PCM oversampling process.

 **DXD.** The unit uses its standard PCM oversampling process for PCM data.

Changing the absolute phase of analogue outputs

When listening to music, if the character of the instruments sounds wrong then it may be because the track was recorded with both channels phase-inverted. You can correct the absolute phase of the outputs.

1. Tap .
2. Tap  to select **Processing**.
3. Tap .
4. Tap  to select **Phase**.
5. Tap  to change between normal phase  and inverted phase .





This setting is reset when you next switch the unit on.

Unlocking and locking volume control

You can unlock the volume control feature and adjust the volume of your unit. With volume control unlocked, you can use LINA Network DAC as a preamplifier.



NOTICE

If you plan to directly connect your LINA Network DAC to a power amplifier, unlock the volume control and reduce the volume level before setting up LINA Network DAC with your system.

1. Tap .
2. Tap  to select **Device Settings**.
3. Tap .
4. Tap  to select **Volume Lock**.
5. Tap  to unlock or lock volume control.





 **Unlock volume control.**

 **Lock volume control.**

6. Confirm the setting change and restart your unit when prompted.
After restarting your unit, volume control appears as a shortcut button and in the Mosaic Control app. The default shortcut buttons now include buttons for adjusting the volume  and Mute/Play/Pause , depending on the input source.

Setting the clocking sync mode

You can change the clocking sync mode for the current input. The sync mode setting is stored separately for each input.

1. Tap .
2. Tap  to select **Device Settings**.
3. Tap .
4. Tap  to change the clocking sync mode.

 **Master.** The unit uses its internal clock to control data delivery from the network, computer or flash drive. For network and USB inputs only. This is the normal mode for these inputs when a Master Clock is not available.



 **Audio.** The unit locks to the data stream from the source equipment. Recommended for sources that do not have a suitable Word Clock input. For use with AES and SPDIF only, with sources that do not have a word clock input that is locked to the Master Clock.

 **Word Clock 1-2 Auto.** The unit automatically locks to the appropriate clock connected to the *WORDCLOCK* inputs. Recommended for systems with a Master Clock in a computer audio system, as the data rate of the music may keep changing.

- Connect the *WORDCLOCK IN 1* input to a Master Clock output set to 44.1, 88.2, or 176.4 kHz.
- Connect the *WORDCLOCK IN 2* input to a Master Clock output set to 48, 96, or 192 kHz.





 **Word Clock In 1.** The unit locks to an external clock connected to *WORDCLOCK IN 1*.

 **Word Clock In 2.** The unit locks to an external clock connected to *WORDCLOCK IN 2*.

 If the unit can't find a word clock that is synchronous with the data on the current AES or SPDIF input, it defaults to audio sync. The incorrect clock icon  is displayed.

Enabling and disabling Dual AES

You can set the AES inputs to be used together to accept PCM data at over 88.2 kS/s or DSD in DoP format from a Dual AES source.

1. Tap .
2. Tap  to select **Device Settings**.
3. Tap .
4. Tap  to select **Dual AES**.
5. Tap  to change the setting.

 **Off.** Disables Dual AES. Each AES input accepts single AES data.

 **On.** Enables manual selection between Single AES or Dual AES.



 **Auto.** This is the recommended setting. The unit detects the data format and automatically selects Single or Dual AES.

Setting the USB audio class

The *USB1* socket supports two audio classes: Class 1 and Class 2.

NOTICE

Before changing the USB audio class, stop playback and close any relevant audio applications on the connected computer.

1. Tap .
2. Tap  to select **Device Settings**.
3. Tap .
4. Tap  to select **USB Class**.
5. Tap  to set the USB audio class.

After you select a different audio class, wait for 10 seconds while the USB software reloads.

Installing the Windows™ driver for USB Class 2





If the USB audio class of the *USB1* socket is set to Class 2, a driver needs to be installed on Windows™ computers before you can connect to the unit.

1. Set the *USB1* socket to Class 2.
 - ▶ For more information, see "Setting the USB audio class" above.
2. If there are any ASIO drivers on the computer, uninstall them.
3. Connect the computer to the *USB1* socket of the unit.
4. Go to www.dcsaudio.com/search/results?q=driver
5. Download the Windows™ USB Class 2 driver.
6. Unzip the file to a temporary directory.
7. Run the file.
8. Follow the on-screen instructions.
9. After the driver is installed, restart the computer.

Enabling and disabling the buffer

By default, there is a buffer delay in the unit. This delay gives the unit time to mute before you hear audible clicks caused by changes in sample rate or clock frequency. The delay is 0.72 seconds with 44.1 kS/s data, and 0.16 seconds with 192 kS/s data.



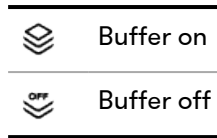

If the unit is connected to a television or video equipment, you may need to disable the buffer to keep the sound in sync with the picture.

1. Tap .
2. Tap  to select **Device Settings**.
3. Tap .
4. Tap  to select **Buffer**.
5. Tap  to enable or disable the buffer.







Changing the line output level

The line output setting sets the maximum output level to suit your integrated amplifier or preamplifier.

1. Tap .
2. Tap  to select **Device Settings**.
3. Tap .
4. Tap  to select **Line Output**.
5. Tap  to change between 0.2 V, 0.6 V, 2 V, or 6 V.

Turning off the display





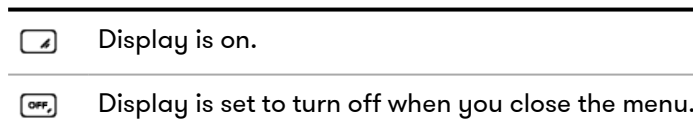

When the display setting is set to off and you close the menu, the display turns off after a few seconds. You can then tap any button to turn on the display briefly. The display stays on while the menu is open.

1. Tap .
2. Tap  to select **Device Settings**.
3. Tap .
4. Tap  to select **Display**.
5. Tap  to change the display setting.







Changing the display brightness

You can change the display brightness.

1. Tap .
2. Tap  to select **Device Settings**.
3. Tap .
4. Tap  to select **Brightness**.
5. Tap .
6. Tap  or  to change the display brightness.

Resetting to factory conditions

You can reset the settings to factory conditions.





1. Tap .
2. Tap  to select **Device Settings**.
3. Tap .
4. Tap  to select **Factory Reset**.
5. Tap  to reset to factory conditions.

The default settings are below.

Setting	Default value
Source	NETWORK
Crossfeed	Off
Filter	Filter 1 for all sample rates
DSD Filter	Filter 1
Upsampling	DXD
Phase	Normal
Sync Mode	Word Clock Auto for Network and USB Audio for AES / SPDIF
Dual AES	Auto
USB Class	Class 2
Buffer	Off
Line Output	2V
Display	On
Brightness	10

Testing for swapped channels

You can test the system for swapped channels.

1. Tap .
2. Tap  to select **Channel Check**.
3. Tap .
4. Tap  to start the test.





The unit outputs a tone on the left channel and then the right channel. If what you hear does not match what is shown on the display, check the connections and other equipment for swapped channels.

Conditioning the unit

You can run a procedure to condition the unit. The system outputs modulated pink noise that increases and decreases.







NOTICE

Conditioning the unit at high volumes can damage amplifiers and loudspeakers. Before conditioning the unit, reduce the volume to a low level. dCS is not liable for any damage to equipment due to incorrect use of the conditioning feature.

1. Tap .
2. Tap  to select **Test**.
3. Tap .
4. Tap  to select **Burn In**.
5. Tap  to start conditioning the unit.
6. After conditioning has started, increase the amplifier volume to a sensible level.
7. Tap any button to stop conditioning the unit.

Viewing information about the unit

Information about the unit can help you solve setup or connection errors.

1. Tap .
2. Tap  or  to select **Information**.
3. Tap  to view information and use  and  to page up and down.



Unit status. Displays the unit status, including:

- Serial number
- The frequency detected on each word clock input
- The sample rate detected on each input
- USB 1 audio class
- IP address



Version. Displays the control board version and Mosaic processor version.

Updating the software

You can update the software on the LINA Network DAC using the Mosaic Control app.

1. On your mobile device, open the Mosaic Control app.
2. Select  > **SUPPORT** > **Versions** > **Check for updates**.
3. If an update is available, follow the instructions to complete the update.

NOTICE

A software update can take up to 45 minutes. Do not switch off the unit until the software update is confirmed on the display.

Maintenance

dCS audio products do not need regular maintenance. The only user-serviceable part of the unit is the mains fuse. If the unit is damaged, contact your fulfilment centre.

Replacing a blown mains fuse

There is a fuse within the unit's power inlet. If the fuse blows, you can replace it.

- If the fuse blows once, replace the fuse. There was a power surge.
- If the fuse blows repeatedly, contact your fulfilment centre to arrange repair. There is a fault in the unit.

Fuse type: 20 x 5 mm, T 1A L / 250 V



WARNING

Replace the fuse with one of the same type and rating. If you use a fuse of a different type or rating, it may damage the unit and there is a risk of fire or electric shock. It also invalidates the warranty.

To replace a blown mains fuse:

1. Unplug the power cable from the unit.
2. Next to the power rocker switch, push the two tabs of the fuse holder towards the centre and pull out the fuse holder.

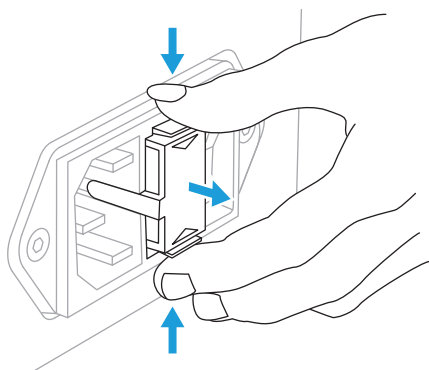

3. Remove the blown fuse from the lower position of the fuse holder.

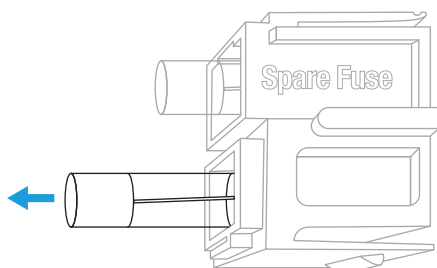

4. Replace the blown fuse with the spare fuse from the upper position.

5. Push the fuse holder back into the unit with the writing the correct way up, until you hear a click.

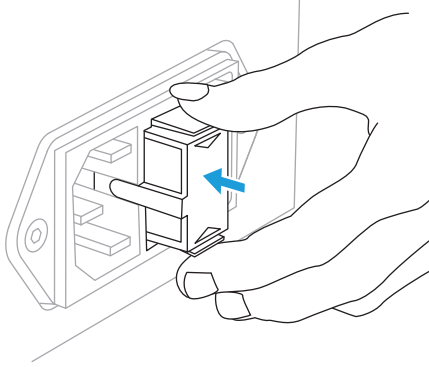

Cleaning the unit

If the case of the unit gets dusty or dirty, you can clean it with a lint-free cloth.

- To remove fingerprints and loose dust, use a clean and dry lint-free cloth.
- To clean any other surfaces, such as the display, use a small amount of glass cleaner containing ammonia and a lint-free cloth. Do not spray glass cleaner directly onto the connector contacts.

Specifications

Converter type	dCS proprietary Ring DAC topology.
Sample rates	Compatible PCM rates are 24 bits at 44.1 kS/s, 48 kS/s, 88.2 kS/s, 96 kS/s, 176.4 kS/s, 192 kS/s, 352.8 kS/s or 384 kS/s. Compatible DSD rates are DSD/64 and DSD/128.
Digital inputs	<p>UPnP Network interface on an RJ45 connector streams music files from a NAS or local computer using MinimServer over an ethernet network. Supports PCM data up to 384 kS/s, or DSD up to DSD/128. Operates in Asynchronous mode.</p> <hr/> <p>1x USB 2.0 client interface on type-B connector:</p> <ul style="list-style-type: none"> • Supports PCM data up to 384 kS/s, or DSD in DoP format up to DSD/128. • Operates in Asynchronous USB mode. <hr/> <p>1x USB 2.0 host interface on type-B connector:</p> <ul style="list-style-type: none"> • Supports PCM data up to 384 kS/s, or DSD up to DSD/128. • Streams audio files from a USB flash drive. • Maximum power delivery is 2.1 A at 5 V DC. • Operates in Asynchronous USB mode. <hr/> <p>2x AES/EBU on 2x 3-pin XLR connectors:</p> <ul style="list-style-type: none"> • Single AES: Supports PCM data up to 192 kS/s, or DSD/64 in DoP format. • Dual AES: Supports PCM data from 88.2 to 384 kS/s, or DSD in DoP format up to DSD/128. <hr/> <p>1x SPDIF on 1x BNC connector:</p> <ul style="list-style-type: none"> • Supports PCM data up to 192 kS/s, or DSD/64 in DoP format. <hr/> <p>1x SPDIF on 1x RCA connector:</p> <ul style="list-style-type: none"> • Supports PCM data up to 192 kS/s, or DSD/64 in DoP format. <hr/> <p>1x SPDIF on 1x TOSLINK connector:</p> <ul style="list-style-type: none"> • Supports PCM data up to 96 kS/s.
Supported file formats	<ul style="list-style-type: none"> • FLAC (supports PCM data up to 384 kS/s) • AIFF (supports PCM data up to 384 kS/s) • WAV (supports PCM data up to 384 kS/s) • ALAC (supports PCM data up to 192 kS/s) • AAC (supports PCM data up to 48 kS/s) • MP3 (supports PCM data up to 48 kS/s) • DFF, DSF and DoP (DSD/64 and DSD/128)
Supported network protocols	<ul style="list-style-type: none"> • UPnP • Airable • Spotify • Apple AirPlay® 2 • Roon Ready <p>Supports TIDAL, Qobuz, Deezer, Internet Radio and Podcasts via Airable. The Network interface operates in Asynchronous mode.</p>

Clocking	2x word clock input on 2x BNC connector: <ul style="list-style-type: none"> • Accept standard word clocks at 44.1 kHz, 48 kHz, 88.2 kHz, 96 kHz, 176.4 kHz or 192 kHz. • The data rate can be the same as the clock rate or an exact multiple (0.25x, 0.5x, 1x, 2x, 4x, 8x) of the clock rate. • Sensitive to TTL levels. 		
MQA	Full decoding and rendering of MQA data from the Network and the USB Type-A inputs. Final rendering of unfolded MQA data only from the other inputs.		
Frequency response (set to Filter 1)	F _s = 44.1 or 48 kS/s F _s = 88.2 or 96 kS/s F _s = 176.4 or 192 kS/s F _s = 352.8 or 384 kS/s DSD64 DSD128	+/-0.1 dB, 10 Hz to 20 kHz +/-0.1 dB, 10 Hz to 20 kHz +/-0.1 dB, 10 Hz to 20 kHz +/-0.1 dB, 10 Hz to 20 kHz +/-0.1 dB, 10 Hz to 20 kHz +/-0.1 dB, 10 Hz to 20 kHz	-3 dB @ >38 kHz -3 dB @ >67 kHz -3 dB @ >100 kHz -3 dB @ >90 kHz -3 dB @ >100 kHz
Residual noise (6V output setting)	16-bit data: Better than -96 dB0, 20 Hz - 20 kHz unweighted. 24-bit data: Better than -113 dB0, 20 Hz - 20 kHz unweighted.		
Upsampling	Multi-stage DXD oversampling with switchable DSD upsampling (1-bit 2.822 or 3.07 MS/s).		
Spurious responses	Better than -105 dB0, 20 Hz - 20 kHz.		
L-R crosstalk	Better than -115 dB0, 20 Hz - 20 kHz.		
Line outputs	1 stereo balanced pair on 2x 3-pin male XLR connectors (pin 2 = hot, pin 3 = cold). These outputs are electronically balanced and floating, the signal balance ratio at 1 kHz is better than 40 dB. Output impedance is 3 Ω , maximum load is 600Ω (a 10 kΩ - 100 kΩ load is recommended). 1 stereo unbalanced pair on 2x RCA Phono connectors. Output impedance is 52 Ω , maximum load is 600 Ω (a 10 kΩ - 100 kΩ load is recommended). Output levels are 2V or 6V rms for a full-scale input, set in the menu.		
Shipping dimensions	320 mm (H) x 360 mm (W) x 530 mm (D)		
Shipping weight	10.3 kg		
Product dimensions	121.5 mm (H) x 220 mm (W) x 339 mm (D)		
Product weight	7.4 kg		
Power requirements	90-120 V / 220-240 V, 50/60 Hz Power consumption: 30 W		



These specifications are subject to change without notice.

Support

If you need help using your LINA Network DAC, contact your fulfilment centre for assistance, quoting the serial number of your unit.

Manufactured by:

Data Conversion Systems Ltd.
Unit 1, Buckingway Business Park,
Anderson Road,
Swavesey,
Cambridgeshire,
CB24 4AE,
UK

www.dcsaudio.com

Limited warranty

General information

dCS warrants this product against defects in materials and workmanship for a period of 3 years from the date the unit was originally shipped from dCS. If the product is purchased and registered with dCS within 6 months of the date the unit was originally shipped from dCS, we will start the warranty on the purchase date. For units registered later than 6 months from the ship date, we will start the warranty from the ship date unless the registration is supported by the original sales invoice. During the first year of the warranty period, dCS will repair or, at our absolute discretion, replace a faulty product. For the remaining two years, service will be covered, but any parts needed will be chargeable. Warranty repairs must only be carried out by dCS or our authorised service agents. Please contact your fulfilment centre if your unit requires service.

To register this product, either register online at www.dcsaudio.com/register or complete the Product Registration form within 30 days of the sale and return it to dCS. On receipt of the registration, dCS will add your contact details to our customer database. dCS will use this information for warranty purposes only, we will not contact you directly for reasons relating to sales and marketing.

This warranty applies to the original owner, it is not transferable.

Warranty exclusions

The warranty does not cover wear and tear.

The warranty on this product will be void if:

- the product is misused in any way.
- any unauthorised modifications or repairs are carried out.
- the product is not used in accordance with the Operating Conditions stated in this manual.
- the product is serviced or repaired other than by dCS or our authorised service agents.
- the product is operated without a mains earth (or ground) connection.
- the unit is returned inadequately packed.

dCS reserve the right to apply a service charge if a product returned for warranty repair is found to be operating correctly, or if a product is returned without a returns number being issued.

This warranty covers parts and labour only, it does not cover shipping charges or tax/duty.

Our fulfilment centres and service agents are not authorised to extend the terms of this warranty, dCS cannot accept responsibility for any attempt to do so.

Products re-sold by dCS on a “used” basis may be subject to reduced warranty terms.

Obtaining service

Should you encounter a problem, contact your fulfilment centre or authorised service centre for help, quoting the model, the serial number, the software version (where appropriate) and giving a detailed description of the fault. Your contact will advise you fully on actions that need to be taken. When returning a unit, the original packaging should be used to avoid transit damage. Replacement packaging sets may be purchased from dCS.











Operating conditions

- The supply voltage must remain within +/-10% of the A.C. voltage specified on the back panel.
- The supply frequency must be in the range 49 Hz to 62 Hz.
- Ambient temperature range: 0°C (32°F) to 45°C (113°F), non-condensing.
- Do not install the unit near heat sources such as radiators, air ducts, power amplifiers or direct strong sunlight.

Compliance

Product label

The product label on the bottom of the unit provides information about the unit, including the serial number. It also displays safety, compliance and regulatory markings.

Marking	Description
	Intended to alert the user to the presence of uninsulated dangerous voltages within the product's enclosure, which may be sufficient in magnitude to constitute a risk of electrical shock to the user.
	Caution: To prevent electrical shock, do not remove covers. No user serviceable parts inside. Refer any servicing to a qualified technician.
	This product is not suitable for operation at altitudes above 2000m.
	The user instructions contain important cautionary information (warnings/precautions) and must be read before using the product. Keep the user instructions in a safe place.
	This product conforms with the requirements set out in the European CE directives when installed and used in accordance with this manual. For continued compliance, servicing must be referred to a qualified service technician.
	The product is compliant with UK standards.
	The crossed out wheeie bin (WEEE symbol) is the European symbol for indicating that this equipment must not be disposed of in general rubbish. You are liable to dispose of all your electronic or electrical waste by relocating to the specified collection point for recycling of hazardous waste. Collection, proper recovery and recycling of electronic waste equipment at the end of the product life cycle will allow us to help preserve the environment. Please return the unit or contact your fulfilment centre for more information.
	The product is compliant with EU2015/863 on restricted substances.
	This equipment has been tested and found to comply with the limits for a Class B digital device, pursuant to Part 15 of the FCC Rules. ► For more information, see "FCC compliance statement" on the facing page.
	This product is in compliance with the China Compulsory safety scheme as administered by CNCA and meets safety and EMC requirements.
	This product is in compliance with Korean product safety and has been awarded the Korean certificate (KC) mark.

FCC compliance statement



This equipment has been tested and found to comply with the limits for a Class B digital device, pursuant to part 15 of the FCC Rules.

These limits are designed to provide reasonable protection against harmful interference in a residential installation. This equipment generates, uses and can radiate radio frequency energy and, if not installed and used in accordance with the instructions, may cause harmful interference to radio communications. However, there is no guarantee that interference will not occur in a particular installation.

You can determine whether this equipment is causing interference by turning it off. If the interference stops, it was probably caused by the equipment or a peripheral device.

If your equipment does cause interference to radio or television reception, try to correct the interference by one or more of the following measures:

- Turn the television or radio antenna until the interference stops.
- Move the equipment to one side or the other of the television or radio.
- Move the equipment further way from the television or radio.
- Plug the equipment into an outlet that is on a different circuit from the television or radio. (That is, make certain the equipment and the television or radio are on circuits controlled by different circuit breakers or fuses.)

(USA only) If necessary, consult dCS Americas LLC or an experienced radio / television technician for additional suggestions.

Changes or modifications not expressly approved by dCS Americas LLC could void the manufacturer's warranty.

This product has demonstrated electromagnetic interference compliance under conditions that included the use of compliant peripheral devices and shielded cables between system components. In order to maintain compliance with FCC regulations, shielded cables (including Ethernet network cables) must be used with this equipment. Operation with non-approved equipment or unshielded cables is likely to result in interference to radio and TV reception.

Responsible party (contact for FCC matters only)

dCS Americas LLC,
PNC Bank Bldg,
300 Delaware Ave, Suite 210,
Wilmington, DE 19801,
USA

EU Declaration of Conformity

This equipment has been tested and found to comply with the essential requirements of the following Directives: 2014/30/EU, 2014/35/EU and 2015/863/EU.

This device is certified for indoor use only.

Korea Class B compliance statement

This equipment is for home use, and has acquired electromagnetic conformity registration, so it can be used not only in residential areas, but also other areas.

이 기기는 가정용(B급) 전자파적합기기로서 주로 가정에서 사용하는 것을 목적으로 하며, 모든 지역에서 사용할 수 있습니다.

Made for iPhone® and iPad®



“Made for iPad” and “Made for iPhone” mean that an electronic accessory has been designed to connect specifically to iPad or iPhone respectively and has been certified by the developer to meet Apple performance standards. Apple is not responsible for the operation of this device or its compliance with safety and regulatory standards.

LINA Network DAC has been certified with the following products:

- iPhone X
- iPhone 8 Plus
- iPhone 8
- iPhone 7 Plus
- iPhone 7
- iPhone SE
- iPhone 6s Plus
- iPhone 6s
- iPhone 6 Plus
- iPhone 6
- iPhone 5s
- iPhone 5
- iPad Pro (10.5 inch)
- iPad Pro (12.9 inch) 2nd Generation
- iPad Pro (12.9 inch) 1st Generation
- iPad mini 4
- iPad mini 3

LINA Network DAC supports iOS 7 or later for setup using Wireless Accessory Configuration.

Works with Apple AirPlay



Use of the Works with Apple AirPlay badge means that an accessory has been designed to work specifically with the technology identified in the badge and has been certified by the developer to meet Apple performance standards.

AirPlay works with iPhone, iPad, and iPod touch, or Mac and PC with iTunes.

Apple, AirPlay, Mac, iTunes, iPad and iPhone are trademarks of Apple Inc., registered in the U.S. and other countries. tvOS is a trademark of Apple Inc.. The trademark “iPhone” is used in Japan with a license from Aiphone K.K.